



Instruction manual SMART PRO

Climatic chambers with ultrasonic humidifier

models: KK 115, KK 240, KK 350, KK 400, KK 500, KK 700,
KK 750, KK 1200, KK 1450

Climatic chambers with steam humidifier

models: KKS 115, KKS 240, KKS 400, KKS 750

Before using the equipment, please read carefully this instruction manual!

Version 1.35
Issued 1.12.2023



POL-EKO A.Polok-Kowalska sp.k.
ul. Kokoszycka 172 C
44-300 Wodzisław Śląski
Country of origin: Polska

As a manufacturer, we inform you that we took the necessary measures to ensure that this device fully meets your expectations and is reliable for a long period of use. Due to the continuous improvement of our products, as well as the expansion of our offer, any suggestions regarding additional functions and equipment functioning are welcome. Visit our homepage www.pol-eko.com.pl/home-en/



Equipment disposal

















This equipment is marked with the crossed out wheeled bin symbol to indicate that this equipment must not be disposed of with unsorted waste. Instead it's your responsibility to correctly dispose of your equipment at lifecycle -end by handling it over to an authorized facility for separate collection and recycling. It's also your responsibility to decontaminate the equipment in case of biological, chemical and/or radiological contamination, so as to protect from health hazards the persons involved in the disposal and recycling of the equipment. For more information about where you can drop off your waste of equipment, please contact your local dealer from whom you originally purchased this equipment. By doing so, you will help to conserve natural and environmental resources and you will ensure that your equipment is recycled in a manner that protects human health.

Thank you!

Contents:

1.	INTENDED USE AND IMPORTANT INFORMATION FOR THE USER	5
2.	PACKAGE CONTENTS	6
3.	BEFORE THE FIRST USE	7
3.1.	Reverse osmosis system (standard for KKS)	9
3.1.1.	Working conditions and requirements	9
3.1.2.	Delivery range	10
3.1.3.	Preparing the system to work	10
3.1.4.	Connecting the system to the KKS chamber	12
3.1.5.	Consumables and service life of reverse osmosis system	15
3.1.6.	Filters replacement FCPS20, FCCBL and FCPS5	15
3.1.7.	Osmotic membrane replacement	16
3.1.8.	Linear cartridge replacement.....	17
3.1.9.	Tank replacement.....	19
3.2.	Installation of a water tank in the KK climatic chamber	20
3.3.	Installation of the condensate tray in KK climatic chamber	21
3.4.	Installation of shelves	24
3.5.	Internal glass door (standard for KK and KKS)	25
3.6.	Condensation in the chamber	26
3.7.	Remarks on the placement of samples.....	26
3.8.	Closing chamber door.....	26
4.	DESCRIPTION OF THE DEVICE	27
4.1.	Design of KK / KKS devices	27
5.	DEVICE EQUIPMENT (standard and optional)	31
5.1.	External door with viewing window (optionally for KK/KKS: 115, 240, 400, 750).....	31
5.2.	Door lock (standard for all units).....	31
5.3.	Access port for external sensor (standard for all units).....	31
5.4.	Open door alarm (standard for all units)	32
5.5.	USB port (standard for all units).....	32
5.6.	Tank water level sensor (optionally for KK)	33
5.7.	Phytotron FIT (optionally for KK).....	33
5.8.	Display battery backup (optionally for KK and KKS)	34
6.	DEVICE OPERATION	34
6.1.	External memory (USB flash drive).....	34
6.2.	First boot.....	35
6.3.	Using the keypad.....	35
6.4.	User logging in.....	36
6.5.	 Main screen.....	37
6.5.1.	Information panel.....	38
6.5.2.	The meaning of icons and symbols	40
6.5.3.	Upper expandable and configurable menu.....	42
6.5.4.	 Quick Note – user’s message	44
6.5.5.	Alarm bar.....	44
6.6.	Quick Program.....	44
6.7.	 Programs.....	47
6.7.1.	Creating / editing a program	48
6.7.2.	Segments edition.....	49
6.7.3.	Phytotron FIT (optionally for KK)	51
6.7.4.	Summary of segments.....	54
6.7.5.	Protection class	55
6.7.6.	Temperature protection	55
6.7.7.	Priority	55
6.7.8.	Loop	56
6.8.	Starting the program	56
6.8.1.	The first way	56
6.8.2.	The second way	57
6.9.	Quick change of parameters.....	58
6.9.1.	Quick change of set temperature	59
6.9.2.	Quick change of set humidity	60
6.9.3.	Quick change of set time	60
6.9.4.	Quick change of fan efficiency.....	61

6.10.		Schedules	62
6.10.1.		Creating / editing a schedule	63
6.10.2.		Starting a schedule.....	66
6.11.		Statistics	68
6.12.		Data record.....	68
6.12.1.		Graph	70
6.12.2.		Data storage directly on a USB flash drive	71
6.13.		Event log	72
6.14.		Info	75
6.15.		Users	76
6.15.1.		Creating / editing a user	77
6.15.2.		Account types and their limits.....	78
6.16.		User settings panel.....	81
6.16.1.		Unlocking the touch screen	82
6.17.		Time	82
6.18.		Alarms	84
6.18.1.		Alarms when set parameters are exceeded	84
6.18.2.		Open door alarm	86
6.18.3.		STM function	87
6.18.4.		Mute option	89
6.19.		Network	89
6.20.		E-mail reports	91
6.21.		Automatic defrosting function (standard for KK and KKS).....	93
6.22.		Corrections.....	94
7.		INTERFACE.....	94
7.1.		MODBUS TCP.....	94
8.		TEMPERATURE PROTECTION.....	95
8.1.		Temperature protection class	95
9.		CONNECTING THE DEVICE TO A COMPUTER.....	96
10.		OPERATION OF THE COOLING SYSTEM.....	96
11.		CLEANING AND MAINTENANCE OF THE DEVICE.....	96
11.1.		Cleaning the housing, condensate tray and pump.....	97
11.2.		Interior cleaning	98
11.3.		Cleaning the touch screen	99
12.		ADVICE ON HOW TO SAFELY STORE THE DEVICE.....	100
13.		TROUBLESHOOTING.....	101
13.1.		Possible defects.....	101
13.2.		Operation times of the UCAN ultrasonic humidifier components	102
14.		WARRANTY CONDITIONS.....	102
15.		RATING PLATE.....	103
16.		TECHNICAL DATA.....	104
16.1.		KK models	104
16.2.		KKS models.....	106
17.		DECLARATIONS OF CONFORMITY.....	107





1. INTENDED USE AND IMPORTANT INFORMATION FOR THE USER

KK and KKS climatic chambers are devices that allow you to control temperature, humidity and optionally illumination. There are two series of chambers that differ in the temperature and humidity range and type of humidifier:

- climatic chambers KK: 0°C ... +60°C, 30%-90% RH, ultrasonic humidifier
- climatic chambers KKS: 0°C ... +100°C, 10%-90% RH, steam humidifier

Climatic chambers have both heating and cooling systems and forced air convection. All devices are controlled by a precise SMART PRO controller, thanks to which the set temperature is maintained with good fluctuation and variation.

The meaning of information symbols

	This symbol means that failure to follow the instructions could endanger people's health or life, or damage the device. The manufacturer is not liable for damages resulting from non-compliance with the instructions contained in the manual.
	A flammable coolant is used in the cooling system. If the cooling system is damaged, ventilate the room carefully and remove all open flames near the unit.
	Warning for devices equipped with UV fluorescent lamps: take special care during work, avoid exposure of the hands and eyes to ultraviolet radiation. This radiation can cause eye damage (conjunctivitis) and skin changes (redness, cancer lesions, etc.). It is recommended not to open the device chamber if UV light is on. The user should be equipped with personal protective equipment (protective gloves, safety glasses).
	This symbol indicates helpful tips.

To guarantee your security and the longevity of the unit, please comply with the following rules:

1.	<u>The unit cannot be installed:</u> <ul style="list-style-type: none"> • outside, • in damp places or places which can be easily flooded, • near flammable or volatile substances, • near acids or in corrosive environments.
2.	<u>It is forbidden to:</u> <ul style="list-style-type: none"> • store inflammable or volatile substances inside the unit, • touch live parts of the unit, • operate the unit with wet hands, • put water vessels on the unit, • climb on the unit, • overload the shelves (the maximum load is described in technical data), • place objects on the bottom of the chamber.
3.	<u>You should:</u> <ul style="list-style-type: none"> • place samples in such a way to provide proper air circulation in the chamber, • open the door for the shortest period of time to reduce temperature fluctuations, • secure samples from being blown out by the chamber fan e.g powdery samples, • always check that the doors are closed correctly, • use only mains with earth to avoid electric shocks, • unplug the power cable holding the protective cover and not the cable itself, • disconnect the unit from the mains before undertaking any repairs or maintenance work (in order to not lose the warranty during its duration, all repairs should be carried out by an authorized service), • protect the power cable and the plug from any damage, • disconnect the power plug before moving the unit, • disconnect the power plug if the device will not be used for a long period of time, • disconnect the unit and protect it from reconnecting if it has any visual fault.

Instruction manual KK, KKS SMART PRO

Failure to comply with the above recommendations may result in damage to the device or deterioration of technical parameters, as well as loss of warranty.

2. PACKAGE CONTENTS

KK SMART PRO climatic chambers are delivered with:

Device	KK (FIT)								
Capacity	115	240	350	400	500	700	750	1200	1450
Shelves [pcs.]	2	3	3	3	3	3	5	2x3	2x3
Slides [pcs.]	4	6	6	6	6	6	10	12	12
Power cord [pcs.]	1	1	1	1	1	1	1	1	1
Rubber cap [pcs.]	1	1	1	1	1	1	1	1	1
Key for door lock [pcs.]	2	2	2	2	2	2	2	4	4
Ethernet cable [pcs.]	1	1	1	1	1	1	1	1	1
Lab Desk program (in the internal memory of the equipment)	1	1	1	1	1	1	1	1	1
Wrench (13mm) for wheels adjustment [pcs.]	x	1	1	1	0	0	1	0	0
Container for deionised water	1	1	1	1	1	1	1	1	1
Shelf for deionised water container	1	1	1	1	1	1	1	1	1
Cuvette with pump for waste water	0	0	0	0	1	1	0	1	1
Drain hose	1	1	1	1	1	1	1	1	1
Inlet hose	1	1	1	1	1	1	1	1	1
Quality Control Certificate [pcs.]	1	1	1	1	1	1	1	1	1

KKS SMART PRO climatic chambers are delivered with:

Device	KKS			
Capacity	115	240	400	750
Shelves [pcs.]	2	3	3	5
Slides [pcs.]	4	6	6	10
Rubber cap [pcs.]	1	1	1	1
Key for door lock [pcs.]	2	2	2	2
Ethernet cable [pcs.]	1	1	1	1
Lab Desk program (in the internal memory of the equipment)	1	1	1	1
Drain hose	1	1	1	1
Reverse osmosis system	1	1	1	1
Quality Control Certificate [pcs.]	1	1	1	1

3. BEFORE THE FIRST USE

The manufacturer sends the device protected by cardboard profiles and foil. The device **should be transported in an upright position** and the package should be secured against sliding during transport.



After receiving the device, visually assess its condition and equipment in the presence of the person delivering the goods. A courier company is responsible for any damage caused during transport.



While carrying the unit, do not tilt it to one side more than 45° from the upright position, as there is a high probability of damaging the compressor. If it is necessary to tilt it to one side more than 45°, then after placing it, please wait about 3 hours before connecting the unit to the mains.



After transporting the device at a temperature below 10°C, wait at least 2 hours before connecting it to the mains.

On the surface of unit's components made of stainless steel, slight discoloration may occur. It is a result of the technologies used in the production of metal sheet in accordance with the requirements of PN-EN 10088-2 standard and it is not a defect of the unit.

The place of installation of the unit should meet the following conditions:

- ambient temperature +10°C...+28°C, for models with glass door +10°C...+25°C,
- recommended relative humidity of the ambient air up to 60%,
- the unit has not been designed to work in highly dusty environments,
- ensure proper ventilation in the room,
- the device should be placed on a hard and stable surface,
- the unit should be placed at least 100mm away from the walls,
- the height of the room must be at least 300mm greater than the height of the unit,
- the unit is not designed to be built-in,
- the place of installation of the device should be equipped with a socket with parameters suitable for the device,
- 3/4" water connection is required for KKS,
- water drainage into the sewage system is required for KKS,
- water drainage into the sewage system is recommended for KK - the cuvette for waste water is equipped with a pump with a maximum lifting height of up to 2 m; the outflow from the pump is an 8 mm hose, which can be connected to the sewage system drainage or a siphon under the sink.

If you don't comply with the above recommendations, it may worsen the technical parameters and may result in loss of warranty.

Level the device after positioning at the destination.

Wheels



The device has been equipped with leveling wheels. After placing the unit at its destination, secure the device against movement by locking the wheels.

Each climatic chamber is equipped with wheels. They must be locked and leveled AFTER placing the chamber in the place of use. For this purpose use the red knob mounted in the wheel housing. At the beginning, the knob can be turned by hand, if it encounters resistance, use a 13 size wrench.

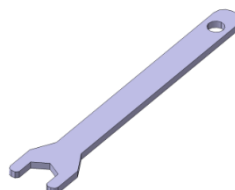



Leveling wheels are ONLY for positioning the device at its destination. They can not be used to transport the device!

Electric installation

The electrical installation should meet the following parameters:

- comply with applicable regulations and standards,
- correspond to the power supply parameters of the device (see [Technical data](#) or [Rating plate](#) section),
- have good grounding,
- the electric circuit should be protected by a fuse with time characteristics B, 16A and a residual current circuit breaker.

Water and sewage installation for the KK climatic chamber with ultrasonic humidifier

The water which powers the ultrasonic humidifier in the chamber can be supplied in three ways: from the container located at the back of the chamber (standard equipment, container assembly see [Section 3.2.](#)), from a deionizer connected directly to the chamber and the water supplied from the network or from the technological line of demineralized water.

The water and sewage installation should meet the following parameters:

- required water pressure in the installation supplied to the chamber 0.1 - 5 bar,
- the humidifier should be supplied with demineralized water with conductivity $\leq 1 \mu\text{S/cm}$,
- the water temperature should be between 5°C and 40°C,
- no organic pollution,
- the sewage system can be open (floor drain) or closed.

Before first use, check that the water inlet valve is open.

The KK climatic chamber is equipped with a pump for pumping out waste water from the cuvette. The drainage hose should be placed in a drainage, a siphon or a sink.

Technical data of the pump:

- maximum pumping height - 2 [m],
- maximum pumping length - 5 [m] (min. 1% slope),
- maximum flow rate - 6 [l/h],
- the pump is equipped with a buffer tank.



Immediately after finishing work, the device cannot be turned off with the main switch. Wait at least 1h. Dripping water can fill the waste water container and get under the device.

Water and sewage installation for the KKS climatic chamber with steam humidifier

The KKS climatic chamber is equipped with a pump for pumping out used water and with a reverse osmosis system, see [Section 3.1.](#) Technical data of the pump:

- maximum pumping height - 2 [m],
- maximum pumping length - 10 [m] (min. 1% slope),
- maximum flow rate - 144 [l/h],
- the pump is equipped with a buffer tank.



Waste water from the KKS climatic chamber must be discharged directly to the floor drain.

3.1. Reverse osmosis system (standard for KKS)

Reverse osmosis system is an effective method of water purification. Reverse osmosis combined with a system of sediment and active filters provides water free of up to 99% organic and inorganic impurities. The system is adapted to cooperate with KKS climatic chambers.

3.1.1. Working conditions and requirements

The place of installation should meet the following conditions:

- recommended ambient temperature from + 5°C to + 30°C,
- the device should be placed on a hard and stable surface,
- the device shouldn't be exposed to direct sunlight and must be away from heat sources,
- the place of installation of the device should be equipped with a water connection $\frac{3}{4}$ "GZ and a drain to the sewage system.

It is forbidden to install the device:

- outside,
- in damp places or places which can be easily flooded,
- near flammable or volatile substances,
- near acids or in corrosive environments.

After placing the device at the destination, it should be leveled.

Required parameters of water going to the reverse osmosis system:







- pressure from 3 bar to 6 bar,



It should be taken into account that the pressure of tap water at night can be much higher than during the day. If the pressure in the installation is below the required minimum, i.e. 3 bar, you should consider buying a pressure boosting pump. In the event of high pressure, use a pressure reducer on the water supply installation.

- temperature from +4°C to +20°C,
- water pH from 6.5 to 8.5,
- maximum water salinity 2000 ppm (mg/l),
- maximum water hardness 400 ppm,
- maximum alkalinity 8 mval/l,
- maximum iron and manganese content 0,05 ppm.

3.1.2. Delivery range

Item	Name	Quantity	Preview drawing
1	reverse osmosis system	1 pcs.	
2	2m hose Ø6	4 pcs.	 <ul style="list-style-type: none"> • WASTE • FEED • DEIONIZED • TO OSMOSIS
3	2m hose Ø12	1 pcs.	 <ul style="list-style-type: none"> • SEWAGE SYSTEM
4	filters key	1 pcs.	
5	membrane housing wrench	1 pcs.	
6	water connection 3/4"GZ (+ blind cover) x 3/4"GW (+hose ball valve Ø6)	1 pcs.	

3.1.3. Preparing the system to work

When the reverse osmosis system is turned on for the first time or after the break for more than 2 weeks or after replacing the filters, flush the filters.

Figure 1 Connection scheme

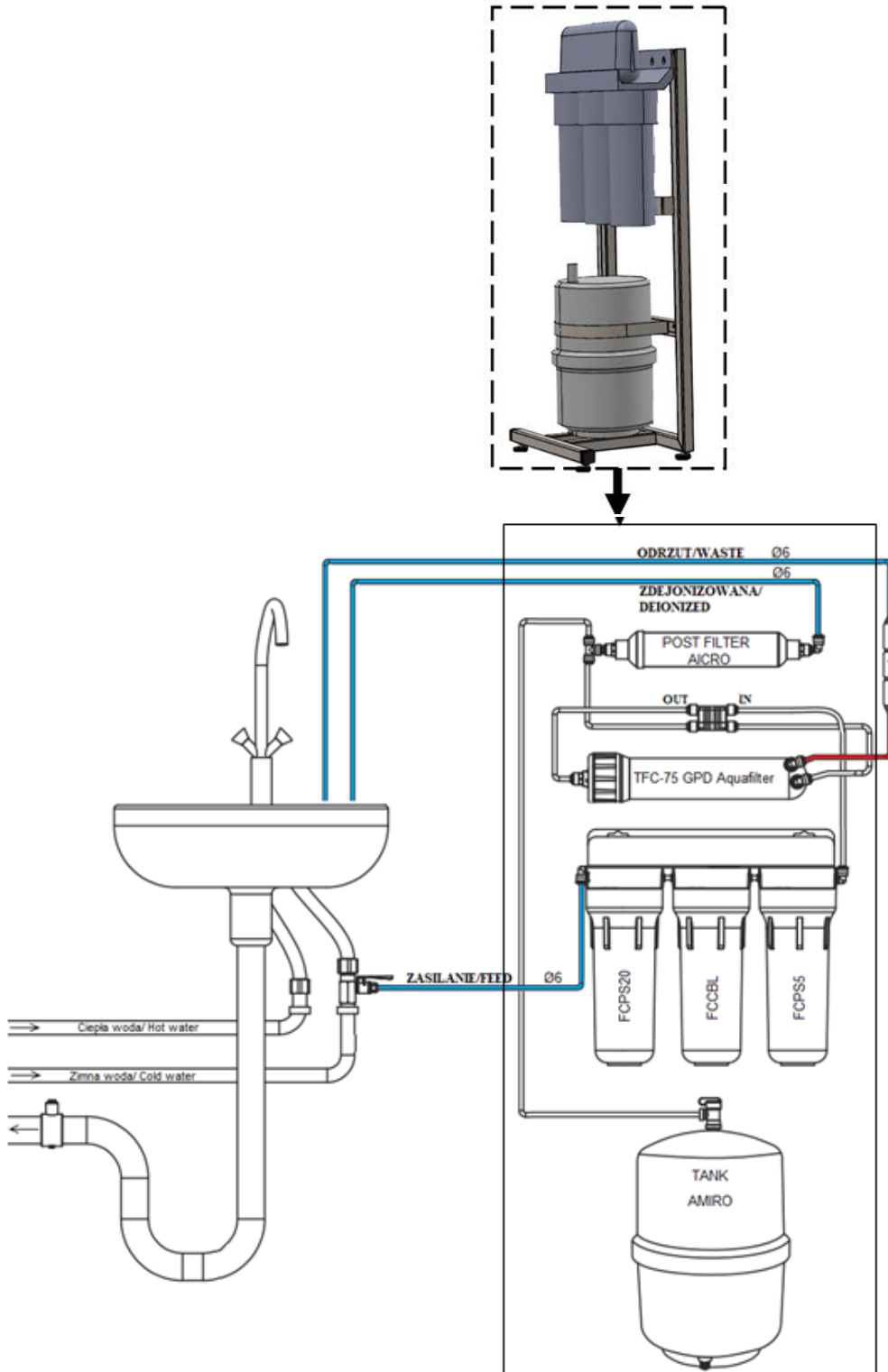

Starting the system (connect according to the above scheme)

1. Connect the hose *FEED* Ø6 to the water connection and to the reverse osmosis system.
2. Connect the hose *WASTE* Ø6 to the drainage (sewage system) and to reverse osmosis system (check valve).
3. Connect the hose *DEIONIZED* Ø6 to the drainage (sewage system) and to reverse osmosis system.
4. Unscrew the tank valve.



5. Unscrew the water supply ball valve.



6. To fill the water storage pressure tank, leave the system for about 2 hours.



Due to the carbon refill, the outflowing water may be cloudy and may have a dark color.

7. Close the water supply ball valve and wait until water stops flowing from the hose *DEIONIZED*.
8. Go to step 5 and perform the flushing procedure again - the system should be flushed twice.



No flushing of the reverse osmosis system in the case of: first use, break in operation for more than 2 weeks, change of filters leads to a deterioration in the effectiveness of water purification and as a result may damage the KKS climatic chamber and void the warranty.

3.1.4. Connecting the system to the KKS chamber

3.1.4.1. Correct hose assembly

To correctly connect the hose to the quick coupler, please follow the drawing below:

Fig.2.

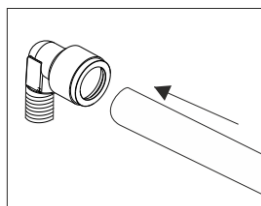
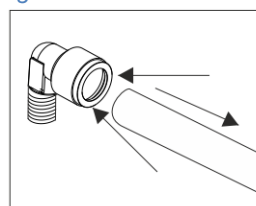

Fig. 3.



Connecting the hose:

1. Push the hose into the quick coupler (Fig.2).

Disconnecting the hose:

1. Press the quick coupling collar symmetrically and pull out the hose (Fig.3).

3.1.4.2. Connecting the system to the KKS chamber

Figure 4 Connection diagram

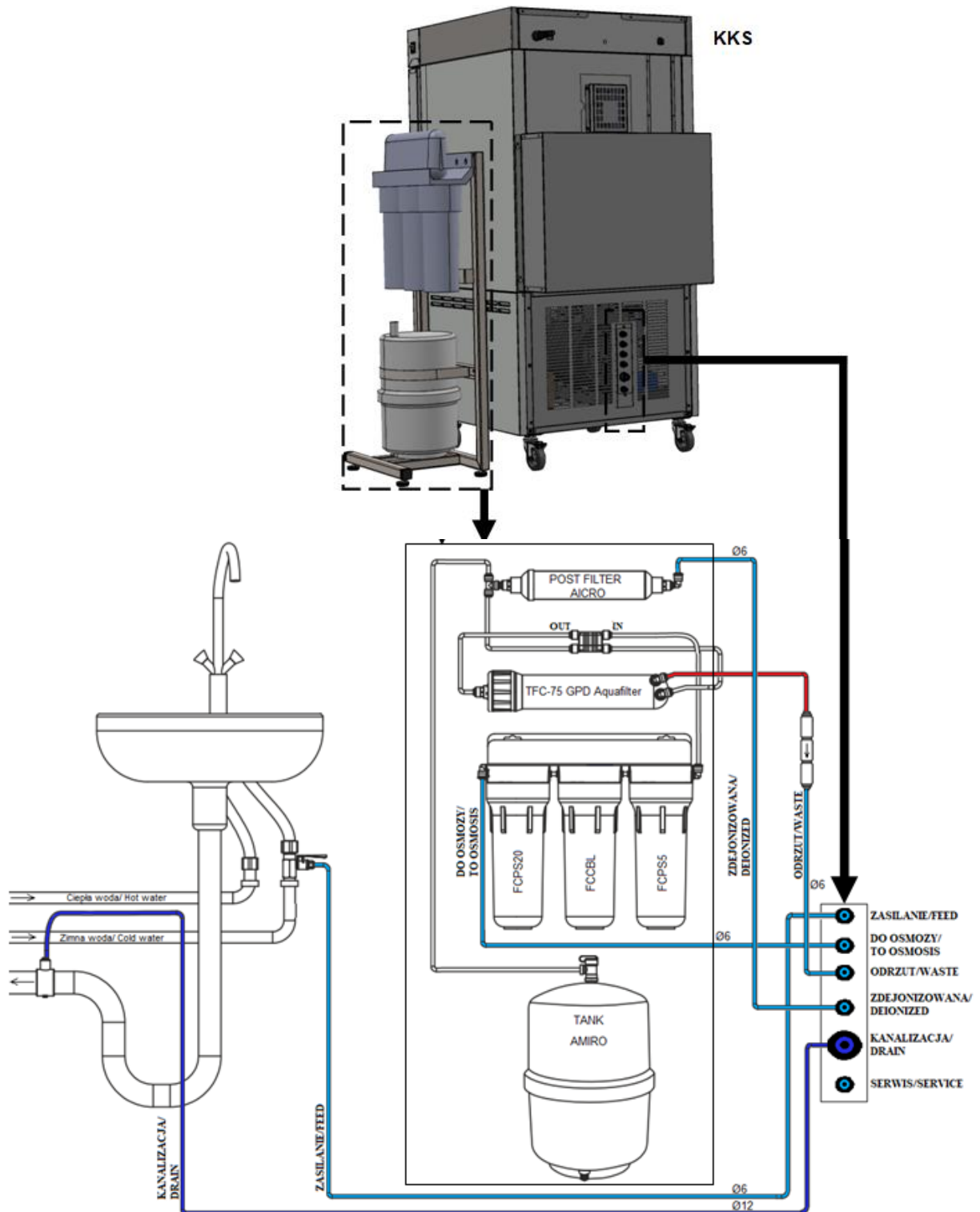

Instruction manual KK, KKS SMART PRO

Connection of reverse osmosis system to the KKS climatic chamber (connect it according to the diagram above)

1. Connect the hose *FEED* Ø6 to the KKS and to the water connection.
2. Connect the hose *TO OSMOSIS* Ø6 to the KKS and to reverse osmosis system.
3. Connect the hose *WASTE* Ø6 to the KKS and to the reverse osmosis system (check valve).
4. Connect the hose *DEIONIZED* Ø6 to the KKS and to the reverse osmosis system.
5. Connect the hose *SEWAGE SYSTEM* Ø12 to the KKS and to drainage (sewage system).
6. Unscrew the tank valve.



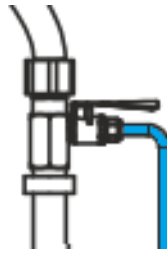

7. Unscrew the water supply ball valve.



8. Turn on the KKS climatic chamber (connect the power plug to the socket and turn the main switch to position I),
9. KKS climatic chamber and reverse osmosis system are ready to be used.

3.1.5. Consumables and service life of reverse osmosis system

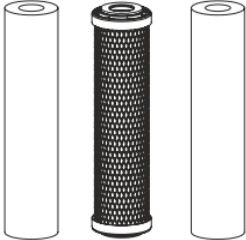
	The user is obliged to perform maintenance throughout the life of the equipment.
---	--

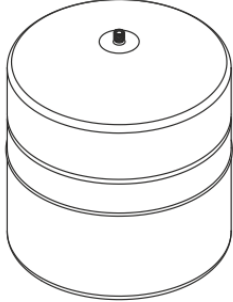
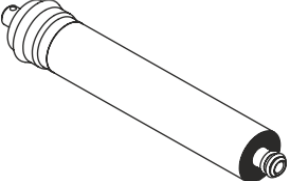
Consumable	Service life (months)	Symbol	Preview drawing
mechanical insert I	6	FCPS20	
carbon cartridge	6	FCCBL	
mechanical insert II	6	FCPS5	
linear cartridge	12	AICRO	
buffer tank	48	PRO4000W or PRO3200P	
osmotic membrane	48	TFC-75 GPD Aquafilter	

The frequency of replacing consumables depends, among others, on water quality and the intensity of system operation. For heavily polluted water, the life of all consumables should be reduced. **Consumables are not subject to warranty replacement.**

3.1.6. Filters replacement FCPS20, FCCBL and FCPS5

Required tools and materials:

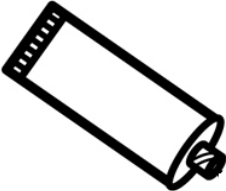
	
Key for filters	technical vaseline

1. Turn off the equipment.



Note: Unplug the KKS climatic chamber from the power socket.

2. Close the water supply ball valve and tank valve.
3. Using a key for filters, unscrew the housings of filter refills and remove used refills.



Note: The housings are filled with water.



Note: Do not change the order of the refills – filters should be replaced in turn.

4. Wash the housings with water and a little of dishwashing liquid, then rinse thoroughly.



Do not use aggressive cleaning agents for cleaning the housings.

5. Insert a new refill into the filter housings, then tighten the housings to the system.



Note: Before bolting the components, grease the housing O-rings with technical vaseline.

6. Rinse the system – see [Section 3.1.3](#).

3.1.7. Osmotic membrane replacement

Required tools and materials:



membrane head wrench

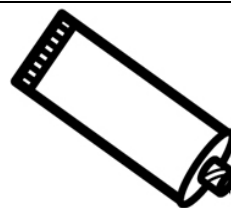

technical vaseline

1. Turn off the equipment.



Note: Unplug the KKS climatic chamber from the power socket.

2. Close the water supply ball valve and tank valve.
3. Disconnect the hose from the housing head.



Note: Remove the blue safety clip before disconnecting the hose.



Note: The system may be under pressure. You should be particularly careful.

4. Use a membrane wrench or manually unscrew the housing head.
5. Remove the used membrane from the housing (*Figure 5*).

Figure 5

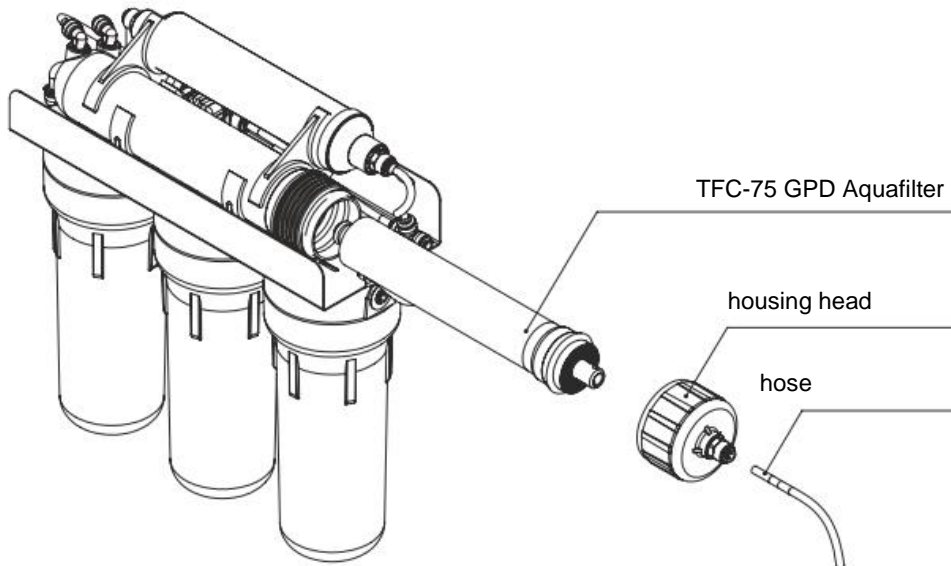

6. Lubricate with technical vaseline rubber seals (O-rings) of the new osmotic membrane and the gaskets in the membrane housing.
7. Install a new osmotic membrane in the housing.



Note: Remove the foil packaging from the membrane.

8. Screw the housing and connect the hose.



Note: Secure the connection with a blue safety clip.

9. Open the water supply ball valve and the tank valve.
10. Turn on the KKS climatic chamber.

3.1.8. Linear cartridge replacement

Required tools and materials:

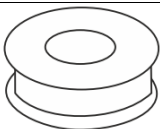
	
teflon tape	wrench 14mm

1. Turn off the equipment.



Note: Unplug the KKS climatic chamber from the power socket.

2. Close the water supply ball valve and tank valve.
3. Odłączyć wężyki od wkładu liniowego.



Note: Remove the blue safety clips before disconnecting the hoses.



Note: The system may be under pressure. You should be particularly careful.

4. Odkręcić złączki ze starego wkładu liniowego:

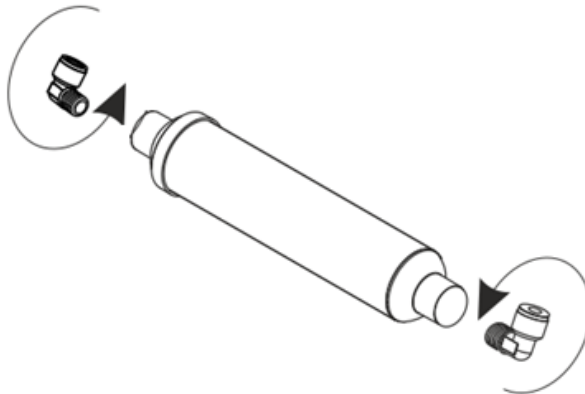

5. Remove the old tape from the connector thread. Wind a few layers of new teflon tape on the connector thread. Wind the tape in the opposite direction of screwing the connector.

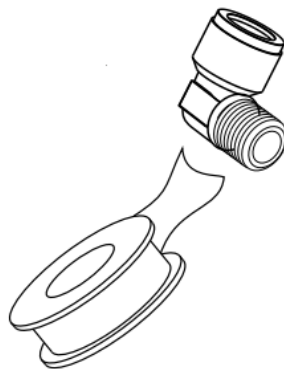

6. Screw the connectors into the new cartridge. Due to the teflon seal, do not pull back the connector when screwing in - it may cause unsealing and water leakage.
7. Connect the hoses.

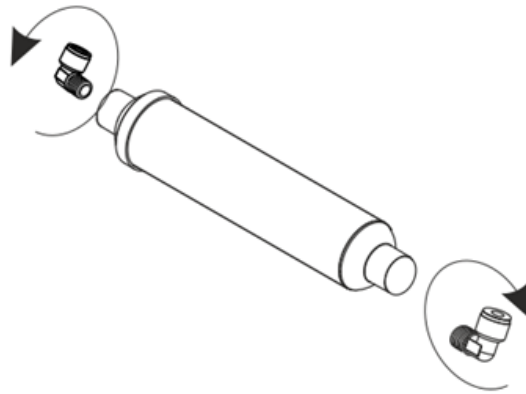



Note: secure the connection with a blue securing clip.

8. Open the water supply ball valve and the tank valve.
9. Turn on the KKS climatic chamber.

3.1.9. Tank replacement

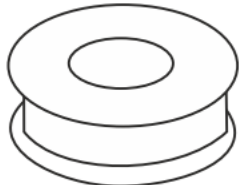
Required tools and materials:

	
teflon tape	wrench 10mm
	
cross screwdriver PH2	

1. Turn off the equipment.



Note: Unplug the KKS climatic chamber from the power socket.

2. Close the water supply ball valve and tank valve.
3. Disconnect the hose from the tank and place it in an additional vessel (to reduce pressure in the system).



Note: Remove the blue safety clips before disconnecting the hoses.



Note: The system may be under pressure. You should be particularly careful.

4. Remove the tank clamp.

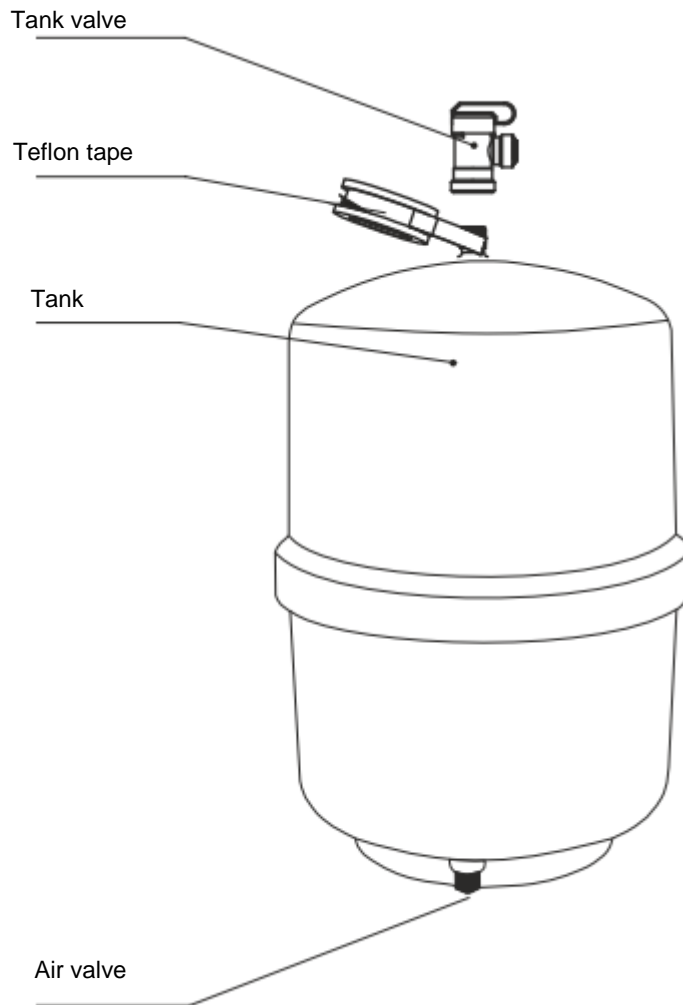

5. Replace the tank.
6. In the absence of a valve in a new tank, screw the valve to seal the thread with teflon tape. Due to the teflon seal, do not pull back the connector when screwing in - it may cause unsealing and water leakage.
7. Connect the hose to the replaced tank.



Note: secure the connection with a blue securing clip.

8. Open the water supply ball valve and the tank valve.
9. Turn on the KKS climatic chamber.

Depending on the pressure in the water mains, the filling may take up to 2-3 hours.

3.2. Installation of a water tank in the KK climatic chamber

Note: does not apply to KKS models.

The KK climatic chamber is equipped with a water tank for a demineralized water as standard. The water in the tank is necessary for the proper operation of the ultrasonic humidifier in the chamber. The water supplying the ultrasonic humidifier can be supplied directly from the deionizer (connected to the climatic chamber) or from the technological line.

The water tank for demineralized water should be placed on a shelf mounted at the back of the climatic chamber. A PZ2 cross screwdriver is required for mounting the shelf.

To mount the shelf you have to:

- screw the two screws attached to the equipment into the upper threaded holes - screw the screws so that there is about 3 mm of space between the wall of the equipment and the screw head,
- the shelf wall should be inserted into the created gap,
- tighten the upper two screws,
- screw the shelf brackets using the remaining two screws.

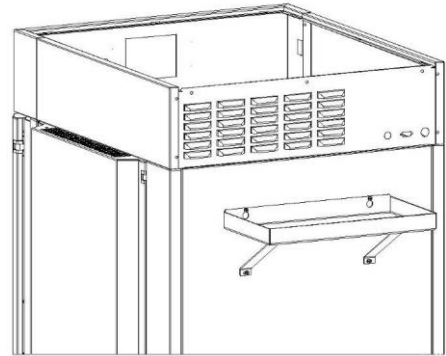

3.3. Installation of the condensate tray in KK climatic chamber

Applies to models KK 500, KK 700, KK 1200, KK 1450.

DON'T APPLY to KKS models.

Together with the climatic chamber, models KK 500, KK 700, KK 1200, KK 1450 are supplied with a condensate tray which must be installed before the first start-up.



Disconnect the equipment's power plug before installing the condensate tray.



The condensate tray MUST be disassembled for the duration of transport.

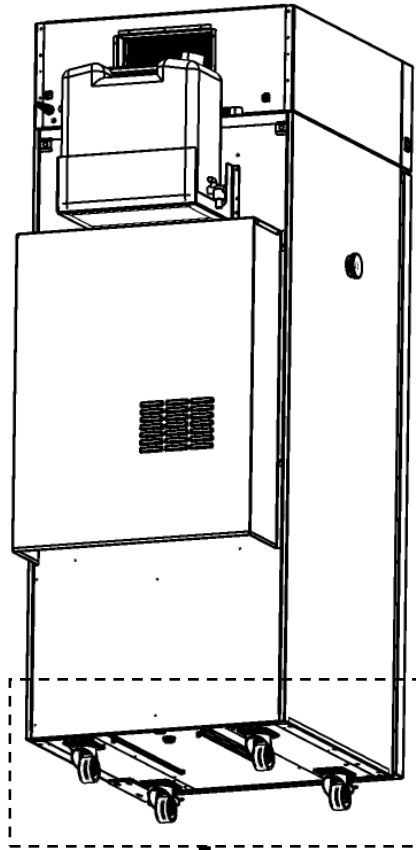

Installation sequence:

1. Connect the orange power cord to the drain pump (1).
2. Slide the condensate tray into the guides under the equipment (2).



condensate tray

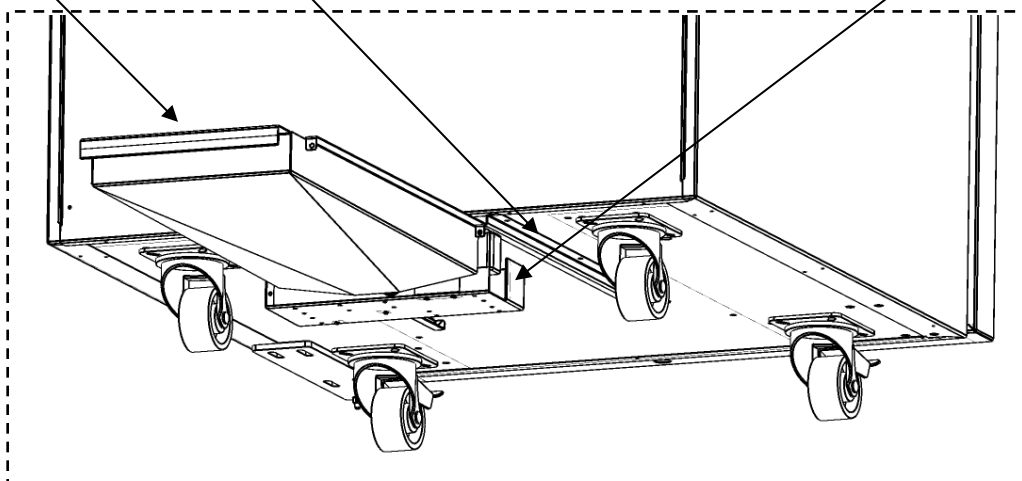

3. Secure the condensate tray by tightening the knurled thumb screws (3, 4)

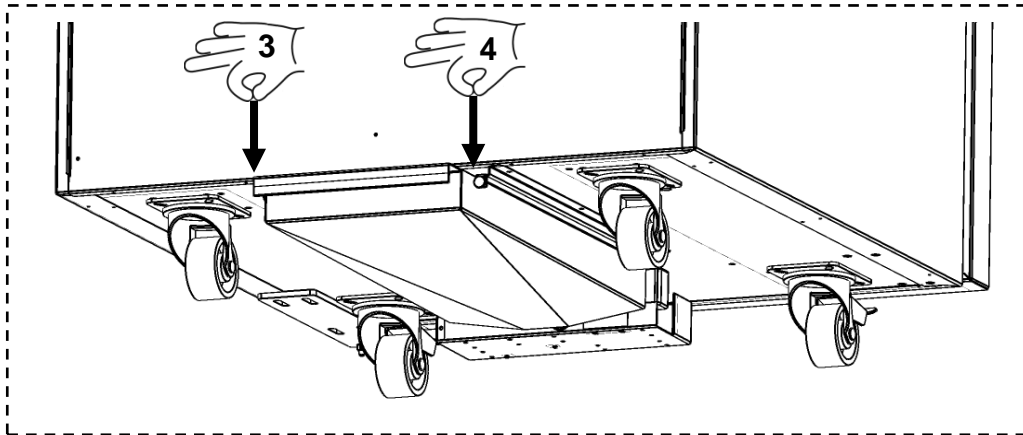

4. Connect the drain hose to eg a sewage system or tank (5)

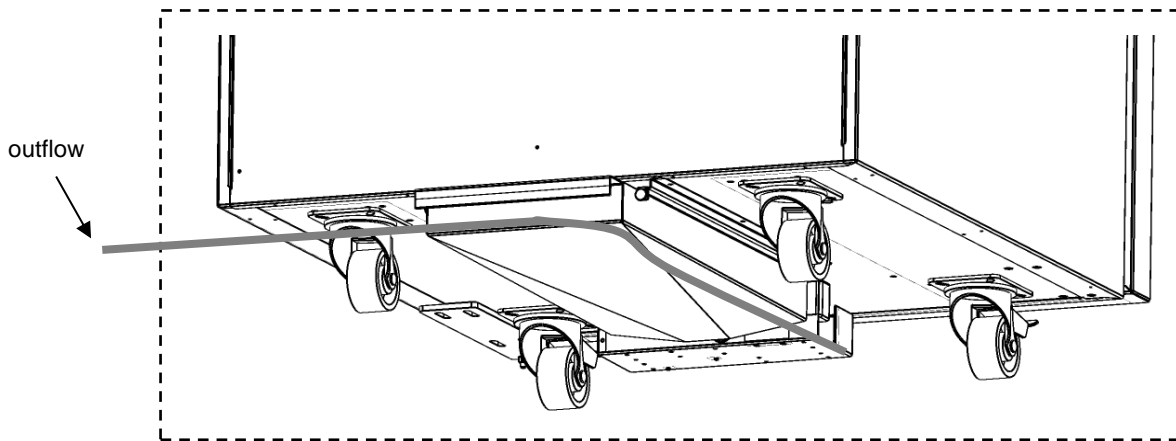

Technical data of the pump:

- maximum lifting height - 2m,
- maximum hose length - 5m (slope min.1%).

Positioning of the hose $\varnothing 6/9$ mm:

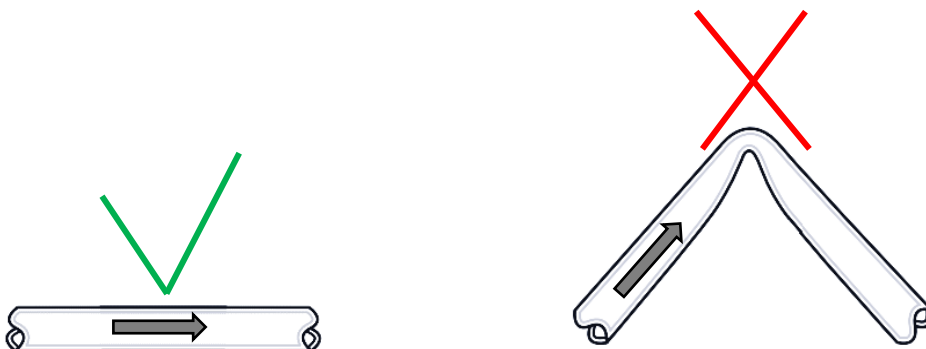

3.4. Installation of shelves

In the KK 350, KK 500, KK 700, KK 1200, KK 1450 models

To install the shelf or to change its position, follow these steps:

Install the shelf slide at the selected height by inserting it into proper slots on the wall of the device. Do the same with the slide on the opposite wall.



Slide the shelf into the installed shelf slides. Now, the shelf is correctly installed!



To remove a shelf, perform the above steps in reverse order.

In the KK/KKS 115, KK/KKS 240, KK/KKS 400, KK 750 models

To install the shelf or to change its position, follow these steps:

Install the shelf slide at the selected height by inserting it into perforations on the wall of the device. Do the same with the slide on the opposite wall.



Slide the shelf into the installed shelf slides. Now, the shelf is correctly installed!



To remove a shelf, perform the above steps in reverse order.

3.5. Internal glass door (standard for KK and KKS)

Internal glass door is a standard equipment in KK and KKS climatic chambers. To open and close the door use the plastic handle attached to the glass so that the glass door does not fall out of the latches..



During operation, when the temperature inside the chamber is high, do not touch the internal components and glass doors, as there is a risk of burns. Use protective gloves to protect yourself against the effects of burns from hot components.



We do not recommend installing and removing internal glass door. Incorrect assembly or disassembly may result in damage to the glass and injury to the user.

3.6. Condensation in the chamber

If the set temperature is much lower than the ambient temperature, condensation may occur, which will cause accumulation of the water at the bottom of the chamber. The amount of accumulated water depends on the following factors:

- the difference between the ambient temperature and the temperature in the chamber,
- frequency of door openings,
- temperature of the samples.



Too high relative humidity in the chamber of the device may cause icing of the cooling element, and thus reduce the cooling capacity and increase electricity consumption.

Cartons, sponges and other hygroscopic materials should not be used to store samples, as they may increase the humidity in the chamber.



Water drainage in climatic chambers is carried out in a gravitational way (not forced). For this reason, remaining small amount of water at the bottom of the chamber is normal. If water accumulates at the bottom of the chamber, wipe the bottom of the chamber with a dry cloth.

3.7. Remarks on the placement of samples

To provide proper air circulation and stable conditions in which the samples are stored in the chamber, it is necessary to keep the following rules:

- the max height of the samples should not exceed 1/3 of the space between the shelves,
- approx. 1/3 of the width and depth of the shelf should remain empty, while the distances between the samples, as well as between the samples and the wall should be approximately equal.

The picture below is an example of the placement of samples in the chamber.

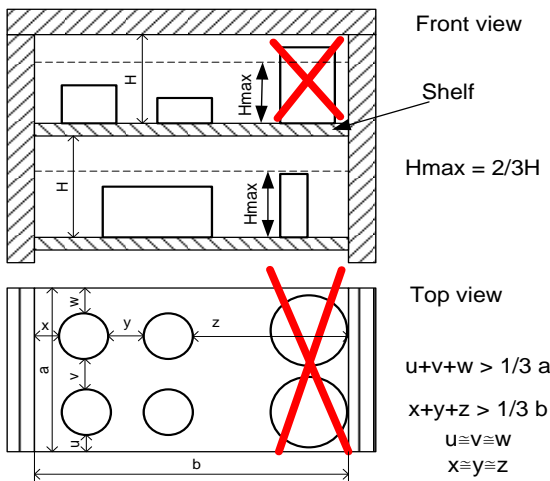

Following the above rules will provide best optimal parameters of temperature fluctuation and variation.

3.8. Closing chamber door

All units have been equipped with a gasket and open door sensor. If the door has not been closed properly, an audible and visual alarm will start. You can set delay door alarm by: 5s, 30s, 1 min, 5 min or 10 min ([see Section 6.18.](#))

4. DESCRIPTION OF THE DEVICE

SMART PRO models are equipped with a PID microprocessor temperature controller and a 7 inch colour touch screen with a resolution of 800x480.

4.1. Design of KK / KKS devices

Below there's a picture of climatic chamber (exemplary photo) with a description of the important components of the device.

Front view

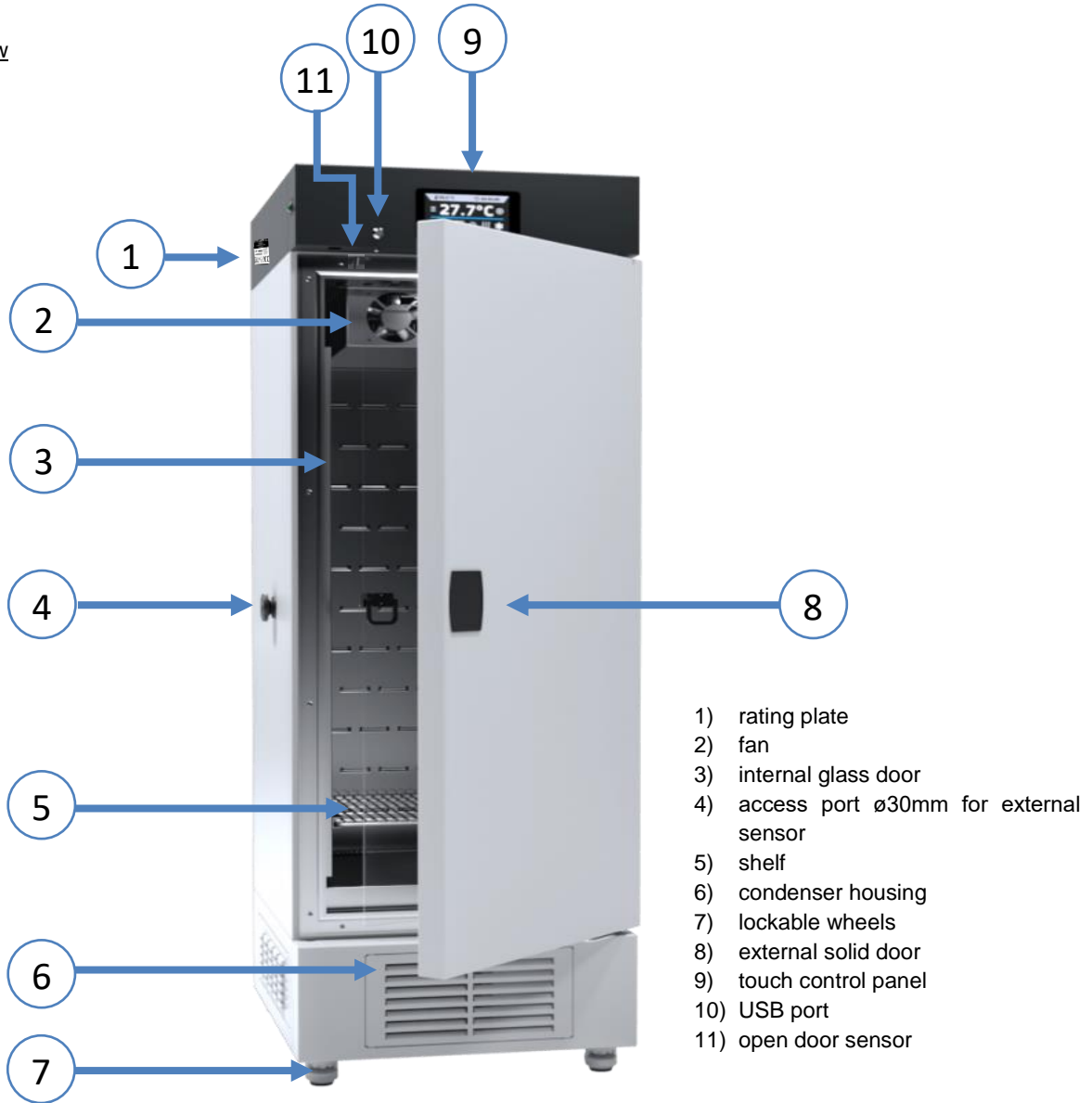

Rear view of KK 500, KK 700, KK 1200, KK 1450 climatic chamber

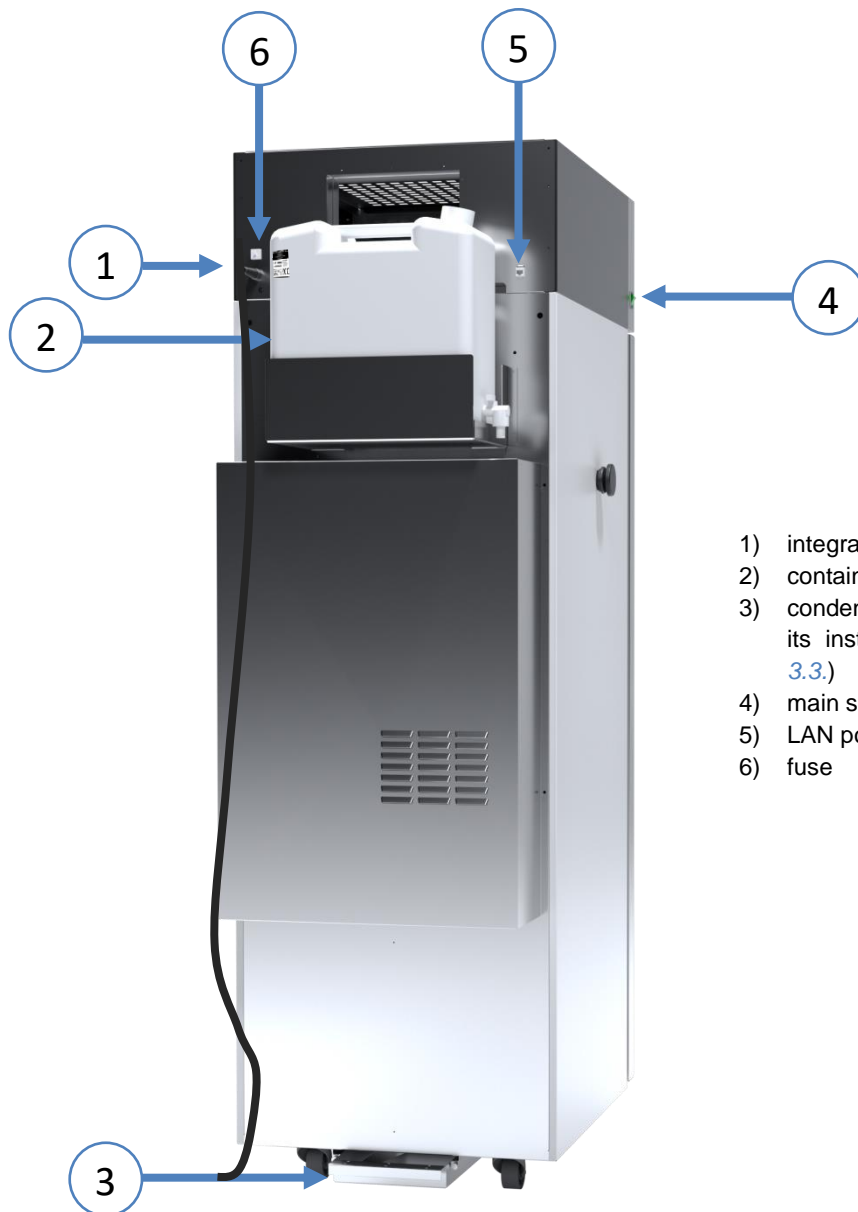

- 1) integrated power cable
- 2) container for deionized water
- 3) condensate tray with a pump (for its installation go to the [Section 3.3.](#))
- 4) main switch
- 5) LAN port
- 6) fuse

Rear view of KK 115, KK 240, KK 400, KK 750 climatic chamber

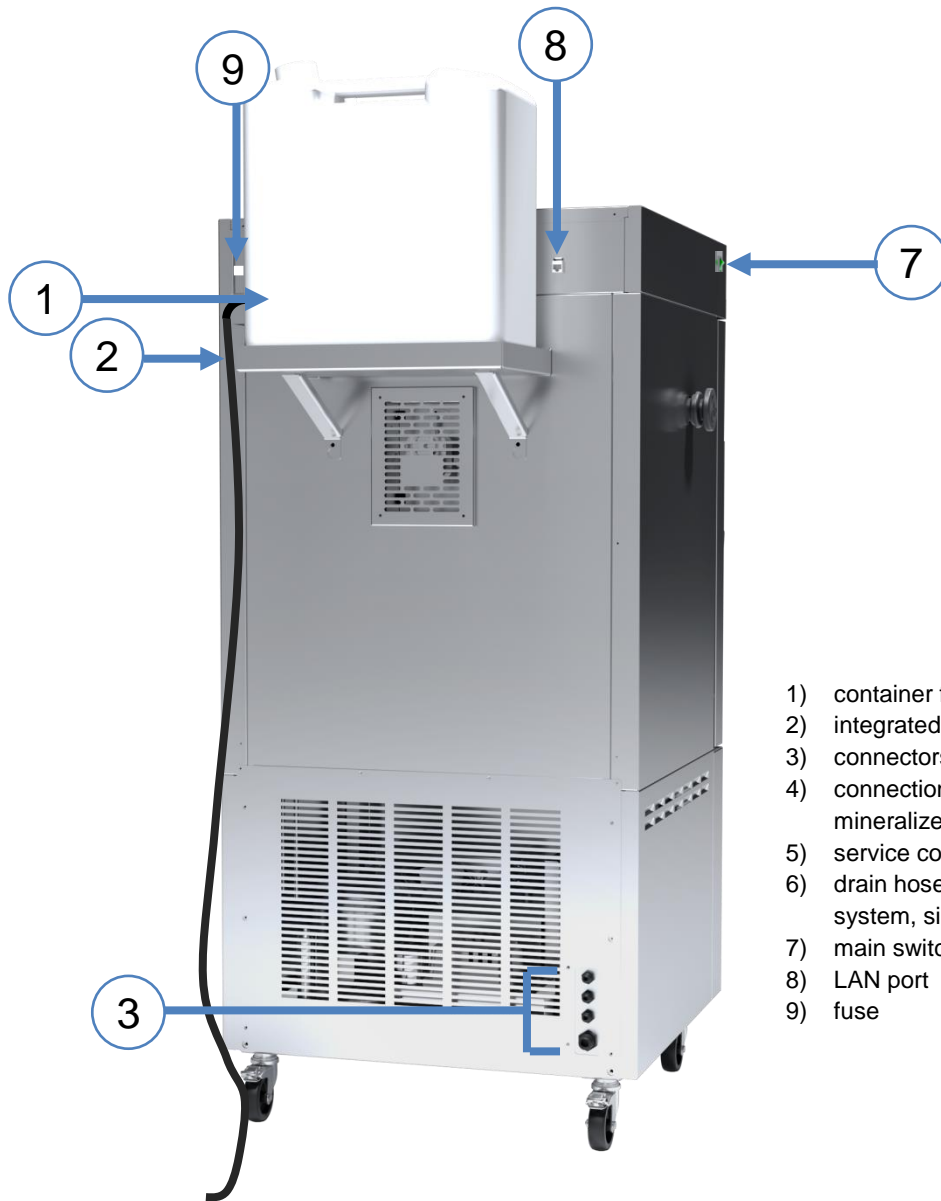

- 1) container for deionized water
- 2) integrated power cable
- 3) connectors
- 4) connection (hose from a tank with de-mineralized water or deionizer)
- 5) service connection
- 6) drain hose connection (to the sewage system, sink, etc.)
- 7) main switch
- 8) LAN port
- 9) fuse

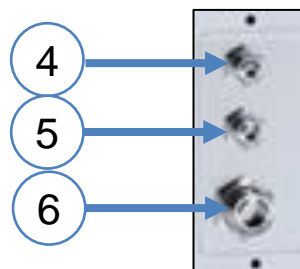

Rear view of KKS climatic chamber

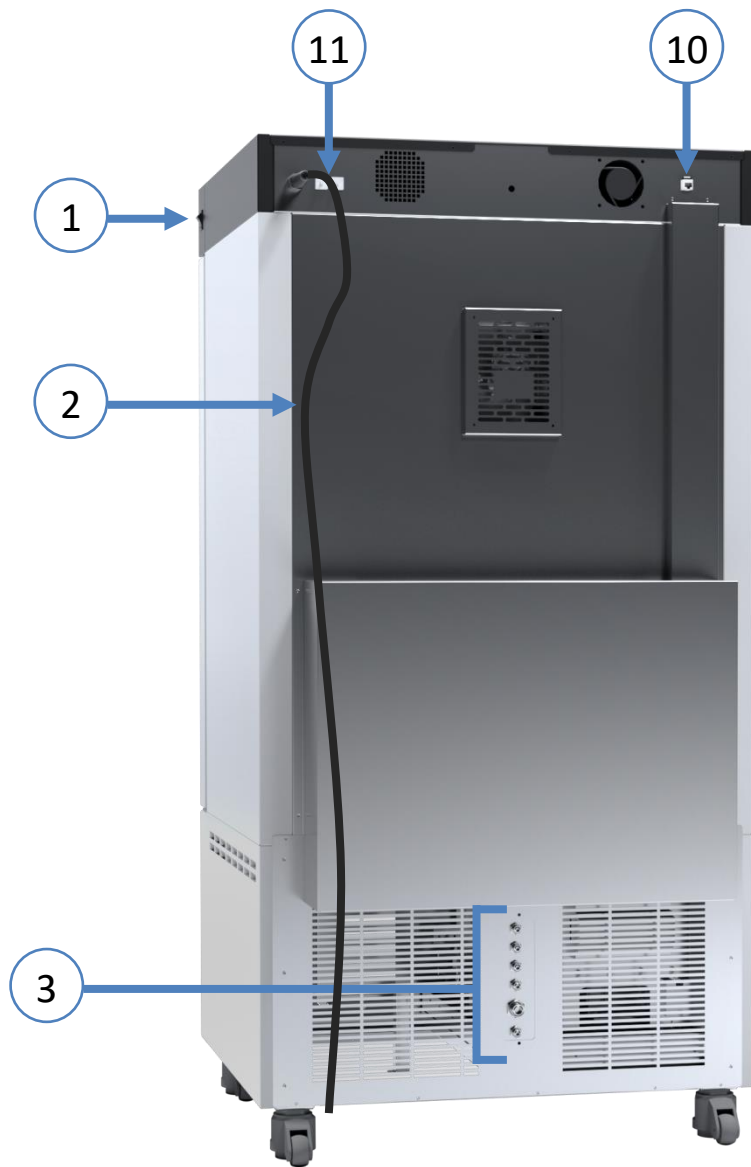

- 1) main switch
- 2) integrated power cable
- 3) connectors
- 4) tap water connection
- 5) connection to the osmosis system
- 6) check valve
- 7) demineralized water connection
- 8) drain hose connection (to the sewage system)
- 9) service connection
- 10) LAN port
- 11) fuse

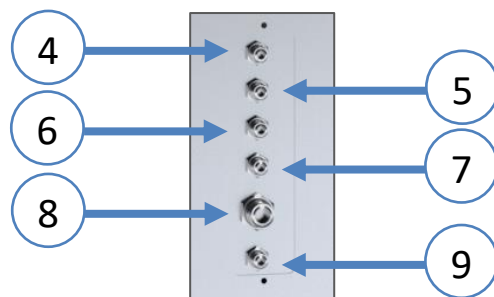

5. DEVICE EQUIPMENT (STANDARD AND OPTIONAL)

5.1. External door with viewing window (optionally for KK/KKS: 115, 240, 400, 750)

The external door with a viewing window is an optional equipment for KK/KKS 115, KK/KKS 240, KK/KKS 400, KK/KKS 750 climatic chamber.



During operation, when the temperature inside the chamber is high, do not touch the internal components and glass doors, as there is a risk of burns. Use protective gloves to protect yourself against the effects of burns from hot components.

5.2. Door lock (standard for all units)

All devices have a key lock. The key lock is situated above the door. Two or four keys are supplied with the device (depending on the model).



5.3. Access port for external sensor (standard for all units)

A Ø30 mm access port can be used to insert an external temperature sensor for independent temperature control inside the device. The access port has been secured with a rubber plug. The plug should cover the access port while the unit is operating. If multiple cables have been inserted through the access port and it is not possible to use the plug, secure the access port with adhesive tape. If you leave the access port open, it may affect temperature fluctuation and variation inside the chamber.







5.4. Open door alarm (standard for all units)

All units have been equipped with an open door sensor. If you open the door, the icon:  will appear (the number above the icon presents open door counter. Press the icon to cancel the counter. The counter is also cancelled by turning of the device). If the door remains open longer than the time set by the user (5s, 30s, 1 min, 5 min, 10 min) an acoustic signal, red pulsating alarm bar and „open door” alarm with active status will appear.



5.5. USB port (standard for all units)

The USB port on the front panel is used only to transfer data from the device's internal memory to the flash drive. To do this insert the flash drive into the USB port on the front panel and then:

- go to the main menu ,
- go to the data record ,
- press  and choose type of the file: *.csv, or *.plx.
- press . Data has been copied.



After copying the data to the USB flash drive, before removing it from the USB socket, it should be unmounted by pressing the icon  in the top drop-down list (Figure 6). If the pendrive is not unmounted after connecting to the computer, a message about pendrive damage may be displayed with a repair proposal, when actually the pendrive is not damaged

Figure 6 Unmounting USB flash drive



Data saved in the *.csv file can be opened in a spreadsheet. Data saved as *.plx can be opened in the Lab Desk program (standard equipment). This program allows, among others, for data preview in the form of a table or a graph. It also allows you to prepare a statistic report for a selected range of data, see Section 6.12.

5.6. Tank water level sensor (optionally for KK)

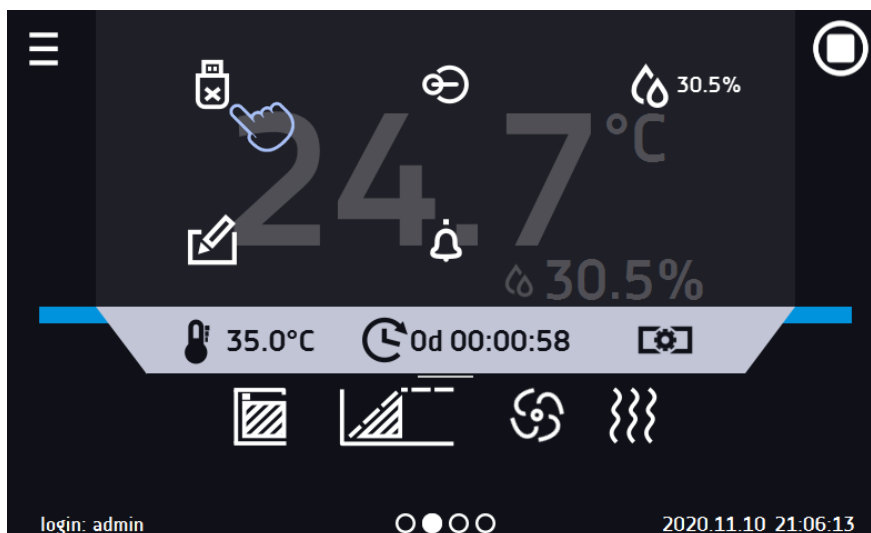
The water level sensor in the tank with demineralized water is an optional equipment for the KK climatic chambers. The low water level in the tank is indicated as an alarm on the display's main panel. Activation of the alarm means the need to refill the tank.

5.7. Phytotron FIT (optionally for KK)

KK climatic chambers can be equipped with phytotron (FIT). Phytotron allows you to program the duration and intensity of light for each segment. Thanks to the phytotron (FIT) function it is possible to: simulate day, parts of the day (e.g.

dawn, noon, dusk), night, etc. If a phytotron is installed in the device, instead of the icon  in the main screen there

is an icon  (internal LED light is not installed in devices with a phytotron) (Figure 7).

Programming options for the FIT version, see [Section 6.7.3](#).

- day and night simulation – it is possible to program temperature, time and intensity of the light for each segment,
- temperature range for „night“: +3...+60°C,
- temperature range for „day“: +10...+50°C,



For devices with a temperature range above +60°C, the range will be factory reduced to +60°C.

- standard fluorescent lamps, type 840, can be mounted in: side walls of the device, door, side walls and door, ceiling or as over-shelf illumination panel,
- operation with priority time.

Figure 7 Main screen for devices with phytotron

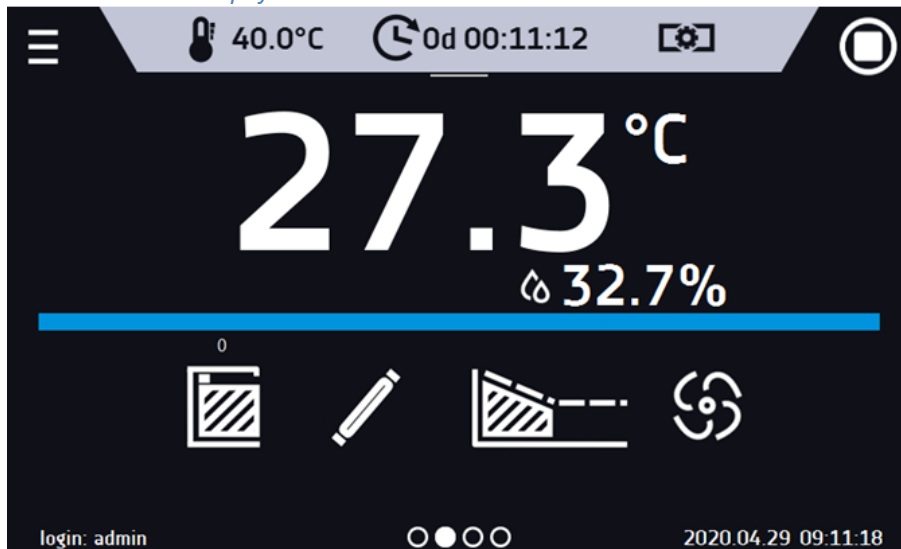

If a phytotron is not switched on, the icon  is inactive. To program a phytotron, see the [Section 6.7.3](#).

5.8. Display battery backup (optionally for KK and KKS)

Climatic chambers in the SMART PRO version can be optionally equipped with a battery backup of the display. The power loss and switching to the battery backup display mode is signaled by a pulsating red frame around the display and a sound signal (if it is turned on). In the battery backup display mode, all parameters are displayed, ie temperature and humidity. Other alarms, e.g. exceeding the temperature range, are also signaled.

In order to extend the battery life, the display is dimmed all the time. Batteries are automatically charged in AC mode.



Batteries should be replaced every 12 months. When it is time to replace the battery, a message will appear on the display, see [Figure 8](#). During the warranty period, the replacement should be performed by an authorized service. Otherwise, you will lose your warranty.

Figure 8 Battery replacement message

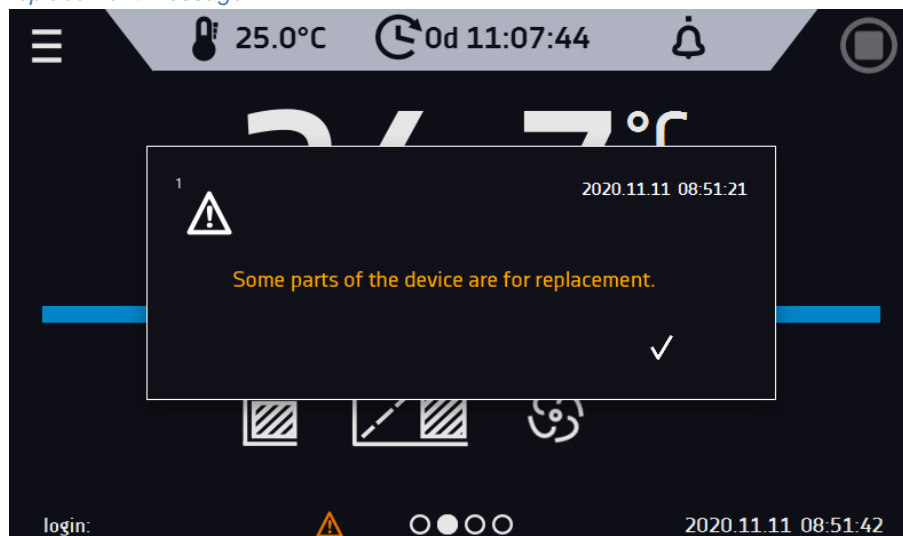

6. DEVICE OPERATION



This symbol means that a given window can be moved in the direction shown in the picture.

6.1. External memory (USB flash drive)

The external memory (USB flash drive) allows to copy: instruction manual, data record, event log and service log from the device memory. Before first use the USB flash drive should be formatted in the FAT 32 file system. Insert the device in the U In order to extend the battery life, the display is dimmed all the time. Batteries are automatically charged in AC mode.SB slot on the front of the device next to the display. Wait a few seconds, the correct reading is indicated by the message „USB flashdrive connected” at the bottom of the screen.



USB slot is used to connect **only** a flash memory – a pendrive or a card reader with a memory card. Connecting any other device (e.g. external hard drive) without consultation is not authorized by the manufacturer and may damage the USB slot.



After copying the data to the USB flash drive, before removing it from the USB socket, it should be unmounted (see [Section 5.5](#)).

6.2. First boot

During the first boot, the screen (Figure 9) will display information about saving the "Download" folder (with instruction manual) on the USB flash drive in pdf format. In order to do it, insert the USB flash drive and wait a second to detect the hardware, then press 

If you press  you quit downloading the folder. The window will appear again during the next boot. You can tick „Don't show again“ so that the window will not be displayed after switching on the device. You can always download the „Download“ folder in the Info submenu. More information [Section 6.14](#).

Figure 9 Downloading files







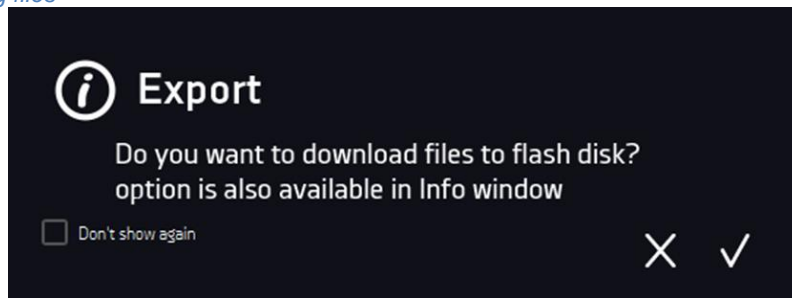

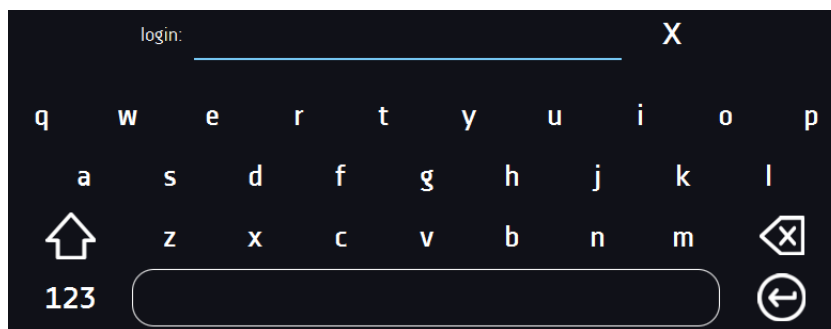
6.3. Using the keypad

When operating the device, sometimes it is necessary to enter alphanumeric characters (e.g. when logging into the system, entering the user name, etc.). In such cases, a keyboard appears on the display screen (Figure 10). In addition to the standard letters, it contains symbols that correspond to the computer keyboard.

Figure 10 Keypad



-  Deleting the entire text
-  Changing to capital letters (it's matters when entering login and password).
-  Changing to numbers and special characters.
-  Changing to letters.
-  Deleting the entered character.
-  Confirming the entered text / closing the keypad.



Sometimes entered characters can be hidden (then they are replaced with „*“). This happens when classified information is entered (e.g. when a user enters a password).

6.4. User logging in

Setting device parameters is only possible by the logged in user. To log in, press  in the main screen. The login window will appear ([Figure 11](#)):

login: from 1 to 10 characters

password: from 1 to 10 characters

Factory default login parameters:

login: admin

password: leave the password field blank

[Figure 11 Login panel](#)

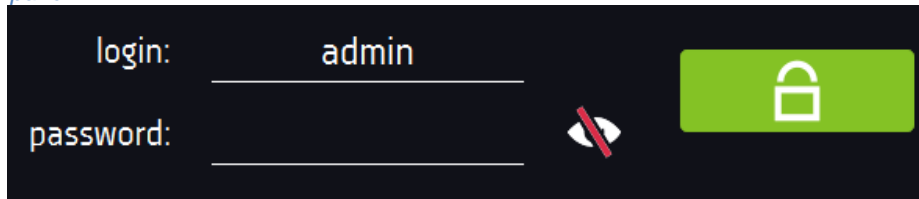

It is recommended during the first boot to set the password of the Admin account and write it down in a safe place to avoid tampering with the device settings by unauthorized persons.



The password should be remembered or noted down because it is not possible to delete the password of the admin account. If you lose your password, please contact the manufacturer's service. Deleting the password is not covered by the warranty.

For information on user account types, see [Section 6.15.2](#).

Logging out: press  in the main menu. For automatic logout, go to the [Section 6.16](#).

6.5. Main screen

After turning on the device, the main screen (*Figure 12*) appears. It contains the information about the device status. After starting the program, additional information appears on the screen (*Figure 13*).

Figure 12 Main screen (program is switched off, no user is logged in)

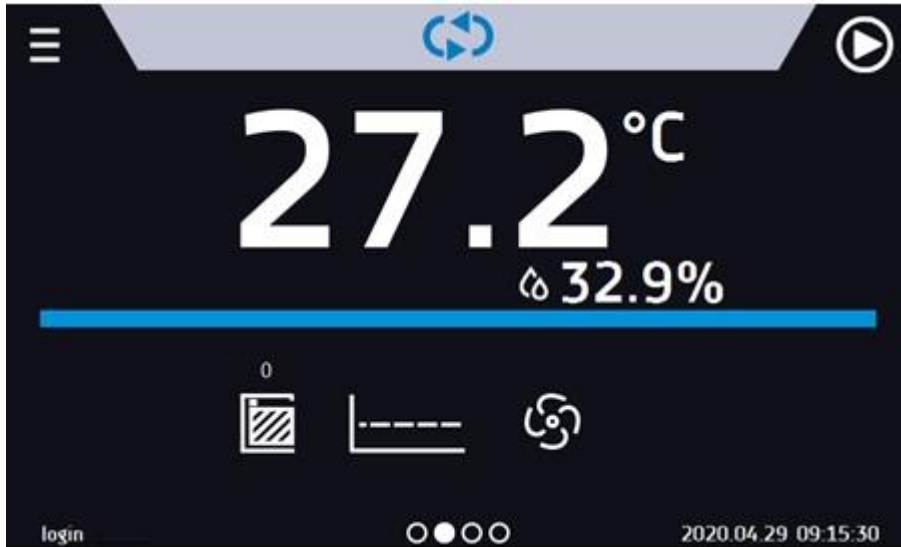

From this point, any action requires logging in.

Figure 13 Main screen – running program in KK

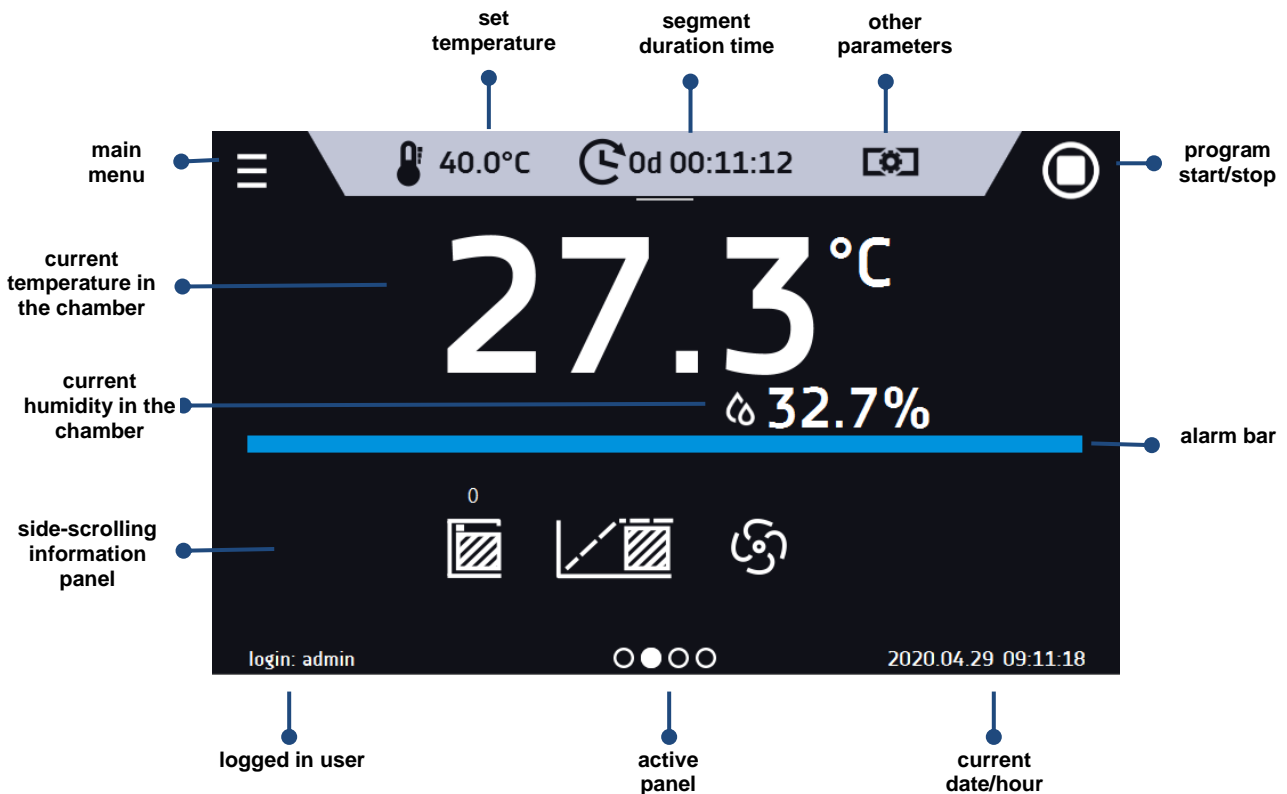



6.5.1. Information panel

There are four different windows in the information panel. Switching between them is done by swiping the finger left or right.

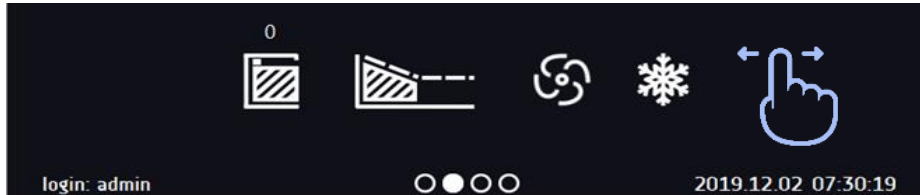

Figure 14 Information panel



The icon  indicates information about which window is active.

6.5.1.1. Alarms panel

On the first page of the information panel there's alarms panel (Figure 15).

Figure 15 Icon: Alarms panel

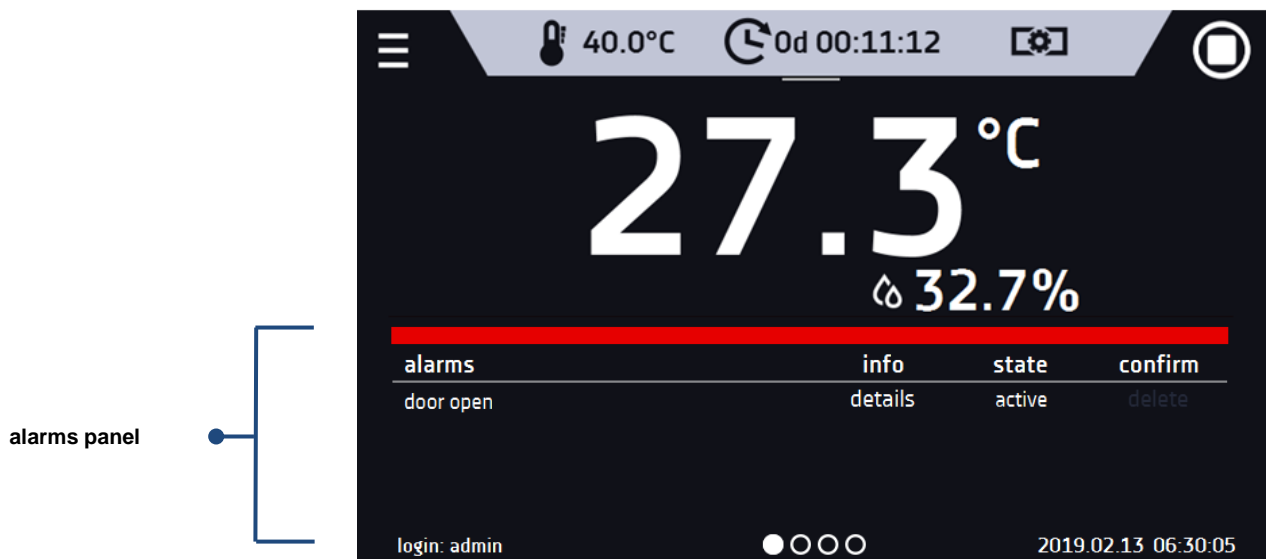

In the alarms panel there's a list with active alarms or the alarms that have occurred but have not been confirmed. When the alarm is active, the alarm bar is red and the alarm event is displayed in the list with the status "active". When the alarm event stops, the state changes to "inactive".

- "delete" button – confirms and removes the alarm from the list (only inactive alarms can be deleted),
- "confirm" button – confirms an alarm,
- "details" button – displays a preview of all instances of selected alarm (Figure 16).

Figure 16 Alarm details

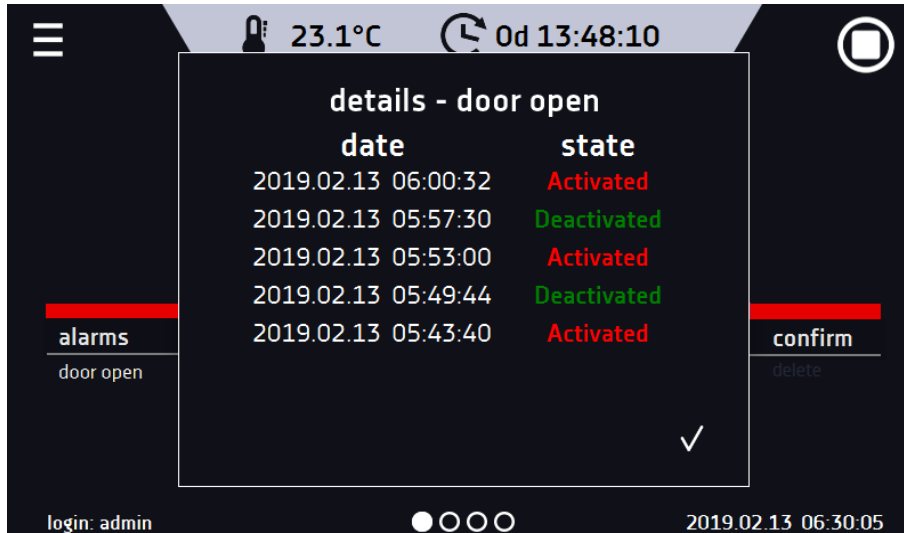

With more alarms, a button  appears on the right side of the list and allows you to enlarge the view to full screen.

6.5.1.2. Status panel

The status of the device is displayed descriptively on the third page of the information panel (Figure 17).

Figure 17 Status - description

program name	program	 status time set time elapsed time remaining	set temperature
program user	a		12d 00:00:00
priority	parameters		0d 00:00:25
current segment	1/2		11d 23:59:35
current loop	1/4		

program name	the name of running program
user	name of the user to whom the program is assigned
priority	of time or parameters
current segment	currently running segment / total number of segments in the program
current loop	currently performing cycle/ total number of cycles to perform
status	stage of device operation, e.g. reaching or maintaining of set temp.
time set	set time of running segment
time elapsed	elapsed time since the segment has started
time remaining	remaining time until the end of the segment

6.5.1.3. Status panel – protection and alarms







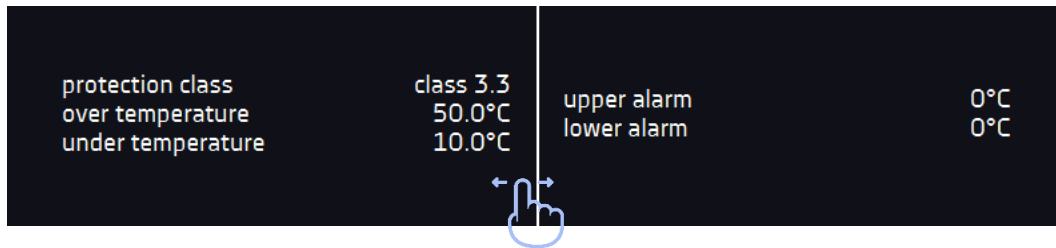







On the fourth page of the information panel there is an information about the protection class along with the set protection temperatures as well as an alarm for the upper and lower temperatures. This information is associated with a running or finished program. To set protection parameters, go to the [Section 6.7.5](#).





The second part of the panel (on the right side) displays information about set upper and lower alarms. To set alarms, see [Section.6.18](#). Value „-“ means the alarm is off.



Figure 18 Status – protection and alarms



6.5.2. The meaning of icons and symbols

	The icon allows you to go to the main screen.
	Automatic return to the home screen. Factory setting: disabled.
	The icon allows you to go to the main menu.
	Automatic logout. Factory setting: disabled.
	Automatic screen lock. Factory setting: disabled.
	The FIT light icon (phytotron, optionally for KK) symbolizes the turned on lighting of the chamber, controlled from the program.
	Unmounting the USB flash drive before removing it from the USB socket.
	Closed door, open door. The number above the icon presents open door counter. Press the icon to cancel the counter. The counter is also cancelled by turning of the device.
	Fan icon. Rotating icon shows that the fan is running. If the icon is not rotating, it means that the program is stopped or the fan is damaged.
	Ramp status: Chamber is currently heating up or cooling down.
	Set temperature is reached.
	The program will start on the given date / time. Schedule or start delay activated.
	Schedule activated - the program will run from-to the given date / time
	Icon is visible only when the chamber is cooling down.
	Icon is visible only when the chamber is heating up.

	Icon is visible only when the automatic defrosting function or defrosting program is running.
	Available when the program is running. Clicking the icon allows you to quickly change the set temperature (Quick Change function).
	When the program is running, click the icon to quickly change the set humidity (Quick Change function).
	When the program is running, click the icon to quickly change the time of program duration (Quick Change function). Indicates the time that has elapsed from the program start.
	Countdown of the time remaining to the end of the program.
	The arrow icon allows navigation between: segments, program parameters and summary.
	Starting the selected program. In the list of programs - the program is running.
	Stopping the program.
	Adding a new program to the program list. The limit is 40 programs.
	Editing the selected program from the list. In the program list, a new program has been created but not approved yet.
	Removing selected program from the list.
	Going to the menu to create, edit, delete and start programs.
	Canceling adding or editing of the program. Cancelling changes.
	Editing individual program segments (the program can have max. 100 segments).
	Immediate start of the program selected from the program list.
	Delayed start of the program from the list of programs. The program starts according to the set date and time.
	Going to the SMART program (Quick Program function).
	Turning off of the alarm sound (open door alarm, exceeding temperature range). Critical alarms (i.e. damage to the temperature sensor, temperature protection, etc.) continue emitting a sound.
	When the program is running, click the icon to quickly change the fan speed (Quick Change function).

	User message. Clicking on the icon allows you to enter a message.
	The icon appears in the event log and symbolizes entered user message.
	Active STM function (Smart Temperature Monitor) informs the user about the problem of reaching or maintaining the set temperature. <ul style="list-style-type: none"> • white color - option enabled, the program is stopped • blue color - option enabled, the program is running red color - warning about problems with reaching / maintaining the temperature

6.5.3. Upper expandable and configurable menu

In the upper part of the main screen there's a bar menu with parameter icons (unmounting USB flash drive, temperature, humidity, time, mute function and fan speed). These parameters can be quickly changed (Quick Change).

After swiping your finger down (Figure 19) you will see icons for all parameters which can be quickly changed (Quick Change, see Section 6.9.) and the USB flash drive unmounting icon (see Section 5.5.). Among the options available in the bar you will find the following icons:







-  USB flash drive unmounting – more information [Section 5.5.](#)
-  Quick Note – more information [Section 6.5.4.](#)
-  mute option. Critical alarms (i.e. damage to the temperature sensor, temperature protection, etc.) continue emitting a sound, see [Section 6.18.1.](#)
- Quick Change (more information [Section 6.9.](#)) of:
 -  program duration time
 -  set temperature
 -  set humidity
 -  fan efficiency

Figure 19 Upper expandable menu when the program is running

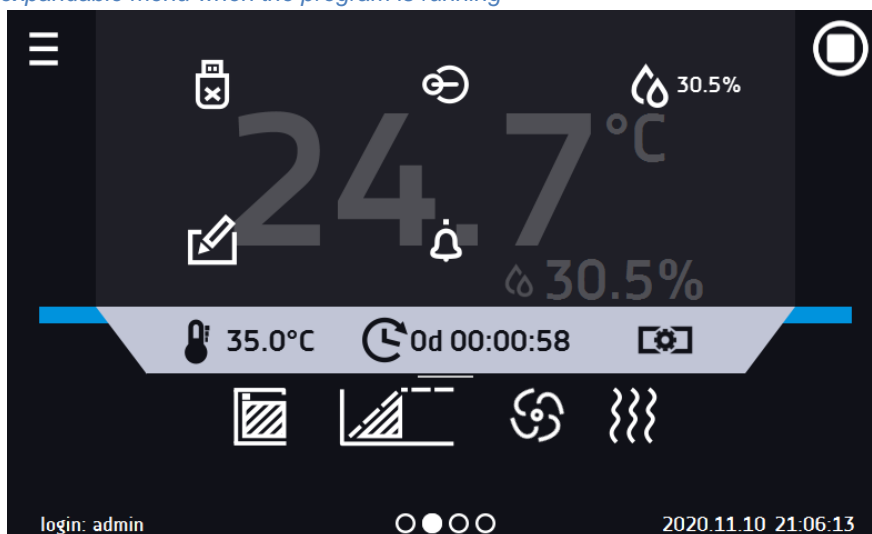
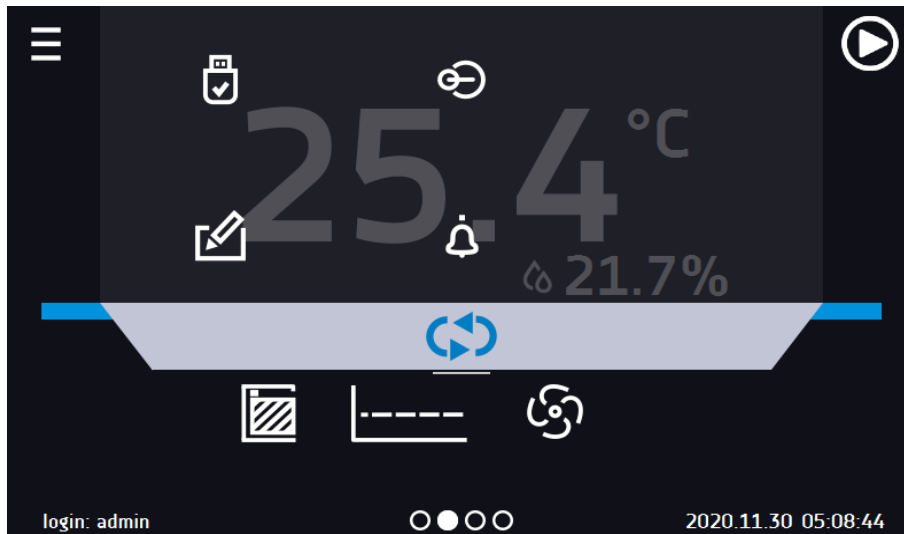
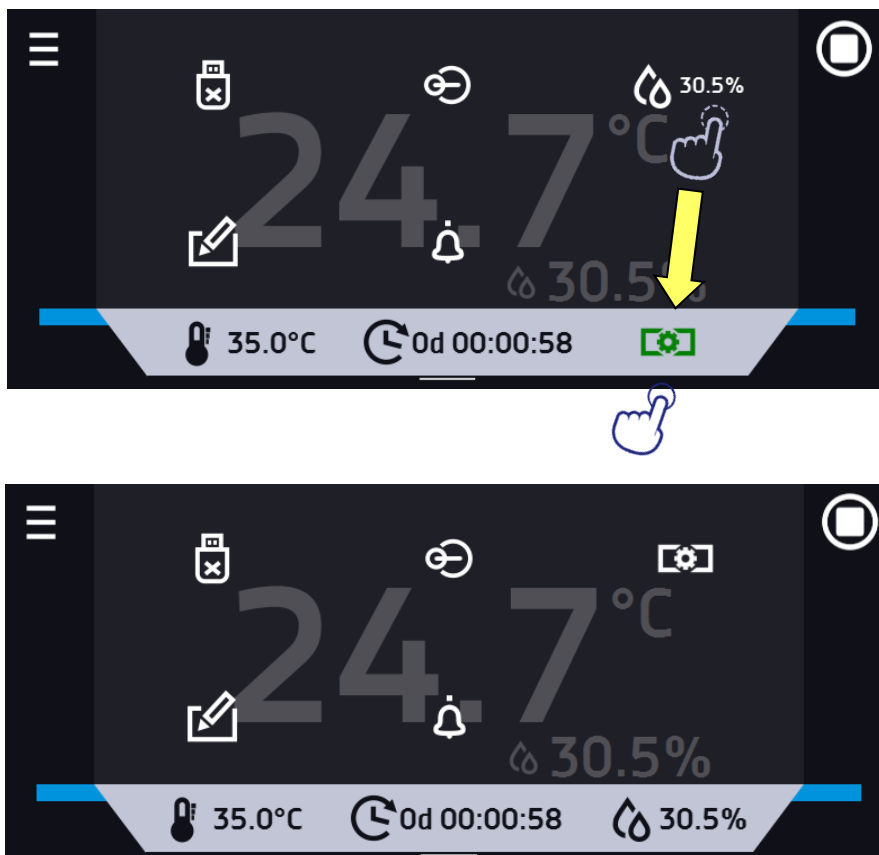

Figure 20 Upper expandable menu when the program is stopped



Positions available on the upper bar can be personalized. Just drag the selected icon to a new location (Figure 21).

Figure 21 Changing icon's position



6.5.4. Quick Note – user’s message



During equipment’s operation, the user can save messages in unit’s memory with information about: the date of inserting a new sample, observed changes in the samples, the place of sampling, etc. To enter a message you must first log in and then press the icon  in the main screen in upper menu. Click on „Write a message” (Figure 22). Using the keypad, enter the message and confirm it with the button . Once entered, a message cannot be changed. Entered notes can be seen in the event log, they are symbolized by the icon . More information [Section 6.13](#).

Figure 22 User’s message



6.5.5. Alarm bar

The Alarm Bar is a quick visual information about the device status. The colour of the bar indicates the status of the device:

 – blue - the device is working properly

 – red bar and pulsating frame – active alarm

6.6. Quick Program

Quick Program allows you to quickly start the program from the main screen position without having to enter to the menu





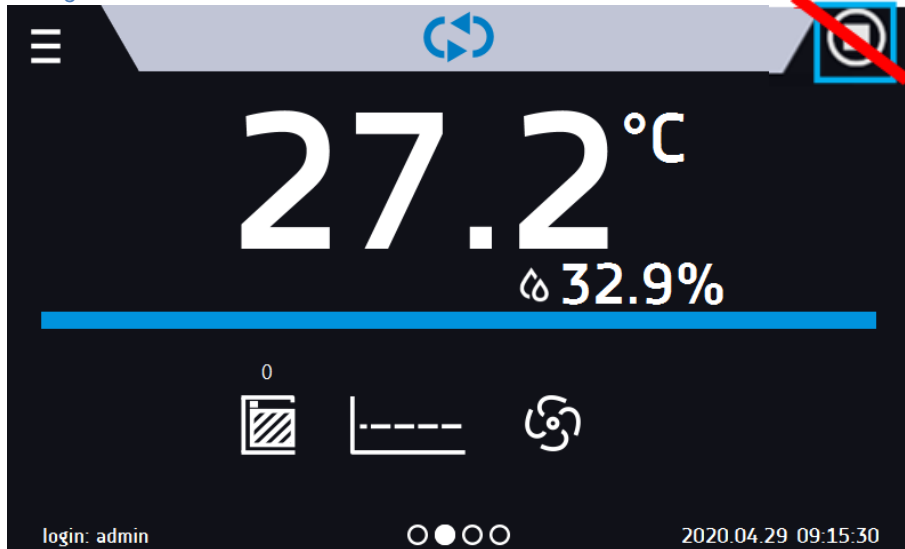

Quick Program has several features that guarantee its uninterrupted operation:

- you can not set the duration of the program - time is always set to infinity,
- if the display fails, the program continues,
- after the power supply is resumed (after its failure), the program continues,
- to prevent the program from stopping accidentally, the STOP button was removed from the main window (Figure 23).

Figure 23 Quick Program



In order to go to Quick Program, first you have to log in (if none of the users is logged in, the icon of Quick Program will be inactive - grayed out). Then click the icon  in the main screen. By clicking the appropriate icon you can set [\(Figure 24\)](#):

-  temperature
-  humidity
-  fan

Clicking the icon  starts the program in continuous mode (time set to infinity).

Figure 24 Starting the Quick Program



Stopping the Quick Program has been made difficult on purpose (this prevents the program from being stopped accidentally) – to stop the Quick Program, you have to:

1. go to the menu ,
2. click the program window ,
3. keep pressing STOP button  for 5 seconds.

After configuration of the Quick Program, it appears in the programs list ([Figure 25](#)). Quick Program is displayed at the top of the list by default. Moreover, it cannot be deleted and cannot be assigned to a user of the User type.

Figure 25 Quick program on programs list

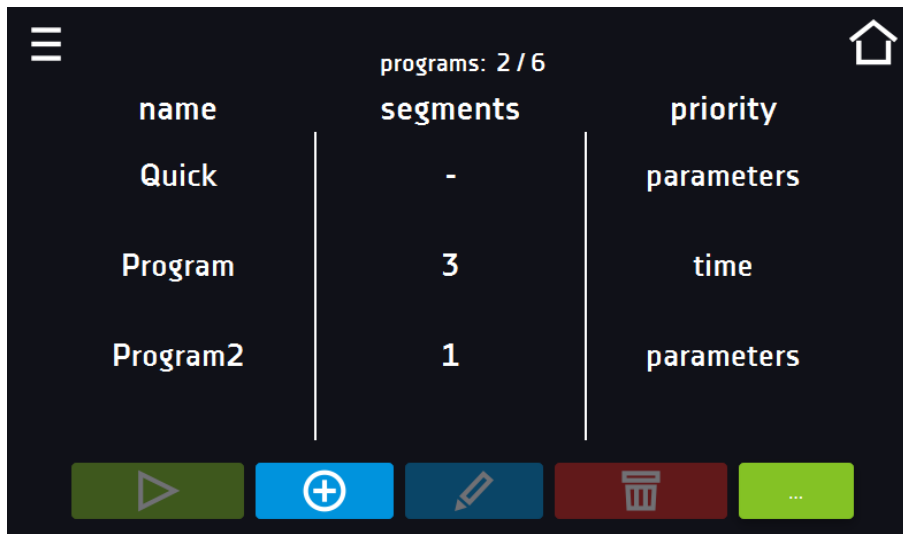



In Quick Program editing mode, you can change:

- settings of the data recording interval,
- settings of the protection class.



Temperature protection

The highest protection class available for the device is set. The protection values depend on the set temperature:

- set temperature $\leq 15^{\circ}\text{C}$: lower protection = set temperature $- 2^{\circ}\text{C}$, upper protection = 30°C
- set temperature $> 15^{\circ}\text{C}$: lower protection = set temperature $- 5^{\circ}\text{C}$ (max 20°C), upper protection = set temperature $+ 5^{\circ}\text{C}$ (min. 30°)

When the program is running you can change the parameters (temperature and humidity) by pressing the icon  or . During next launch of the Quick Program, your previous settings will be remembered.

6.7. Programs

Press the icon of main menu , and then press . In this panel (Figure 26) you can run the selected program, add a new one, edit the program, delete it or share it with another user and download the program from a USB flash drive. The number of programs that can be created depends on the limit assigned by the **Super Admin** user. More information on the rights and configuration of account types (Super Admin, Admin, User) see [Section 6.15.2](#).









-  Start the selected program.
-  Stop the program.
-  Add a new program.
-  Edit the selected program.
-  Delete the selected program.
-  Download program from USB flash drive.
-  Share the selected program with the user type account.

Figure 26 List of programs

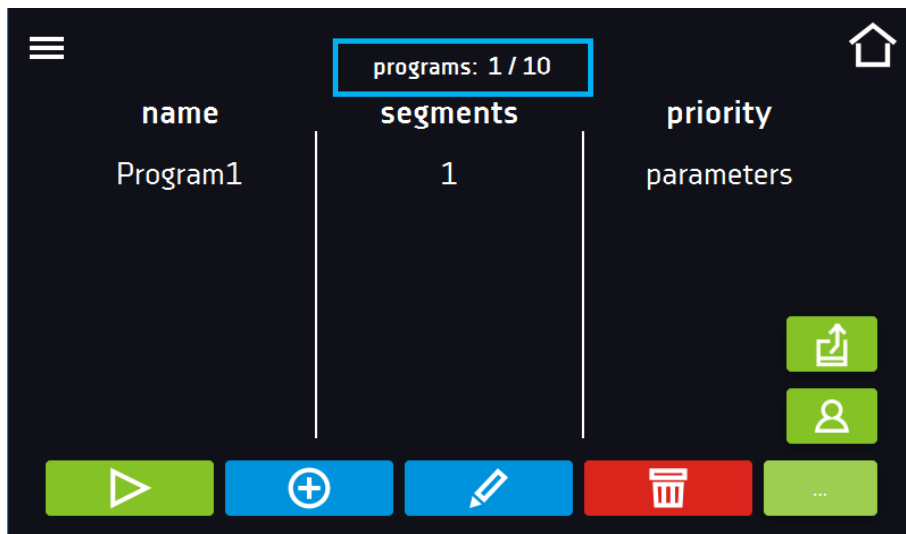

Information on the number of created programs / the maximum number of programs that the user can create is at the top of the screen (programs: 1/10).

6.7.1. Creating / editing a program

Press the button  or  and a panel with program parameters will appear (Figure 27). In this panel you can set:

- **Program name** – after clicking, the keypad will appear and you will be able to enter the program name,
- **Segments number** – max. 100 segments
- **Interval** – frequency of saving the data in the data record (1 min, 2 min, 5 min, 10 min, 15 min, 30 min, 1 h), more information
- **Protection class** – more information [Section 6.7.5](#).
- **Temperature protection** – temperature range for the protection class, more information [Section 6.7.6](#).
- **Priority** – the priority of time or parameters, more information [Section 6.7.7](#).
- **Loop** – the number of program repetitions, more information [Section 6.7.8](#).

Figure 27 Program parameters

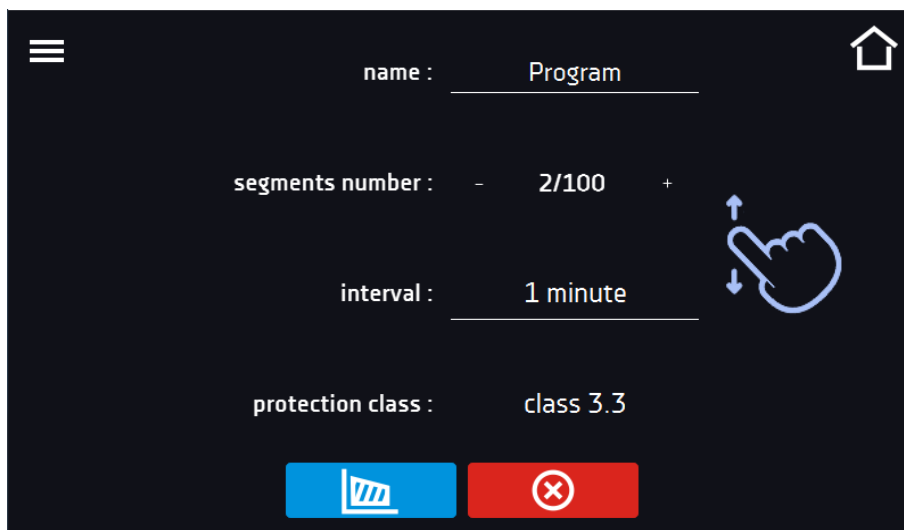

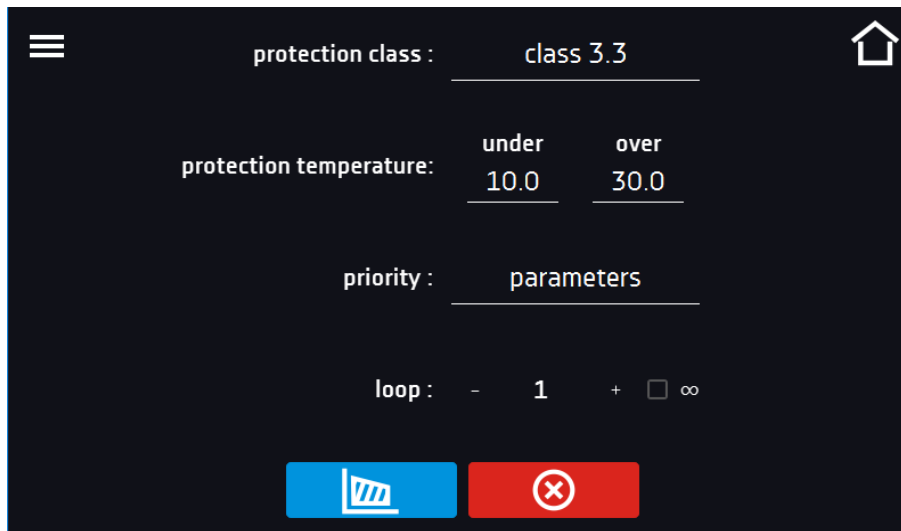

Cancels adding or editing of the program.



Going to the edition of program segments.



With more parameters, the window can be scrolled up and down.

6.7.2. Segments edition

For each program, you can set maximum 100-segment time-temperature profiles that allow you to gradually increase or decrease the incubation temperature of the samples. This can e.g. protect the sample from so-called thermal shock. Example of program operation with programmed segments (parameters priority):

Program 1

- segment1: temp. 30°C and 60%, time 2 hours (after reaching the parameters, they are maintained for 2 hours)
- segment2: temp. 30°C and 70%, time 2 hours (after reaching the parameters, they are maintained for 2 hours)
- segment3: temp. 40°C and 70%, time 2 hours (after reaching the parameters, they are maintained for 2 hours)
- segment4: temp. 50°C and 80%, time 2 hours (after reaching the parameters, they are maintained for 2 hours)
- segment5:
- segment6:

Press the button  and the first program segment will appear (Figure 28).

In this window you can set:

- **temperature** – target temperature which the device is to achieve in this segment (needs to be minimum 2°C below the value for over temperature protection and minimum 2°C above the value for under temperature protection)
- **time** – the time of maintaining the set temperature ([d hh:mm]) in days, hours and minutes. It is possible to select continuous work ∞ in the last segment
- **ramp time** – the time of reaching the set temperature ([d hh:mm]) in days, hours, minutes
- **fan** - fan efficiency in percent
- **fan ramp** – fan efficiency when reaching the set temperature
- **light (phytotron)** – setting the FIT light in the segment (option for KK)

The active value is highlighted in blue. The item highlighted in red means that the value is out of range and you should enter another one, e.g. the temperature is above / below the operating range of the device or the protection temperature.



The fan efficiency set to 100% is the default value. Reducing the fan efficiency may cause improper operation of the device, e.g. chamber icing, worse fluctuation and variation of temperature, excessive condensation of water.



Ramp time - setting a short time will not accelerate reaching the ramp, but the ramp will be reached in the shortest possible time depending on the set temperature, ambient conditions and the possibilities of the cooling or heating system in the device.

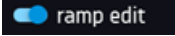

The ramp parameters are factory set in accordance with the manufacturer's instructions. If it is necessary to set individual parameters when reaching the segment temperature, activate the edit ramp field  and set your own values.

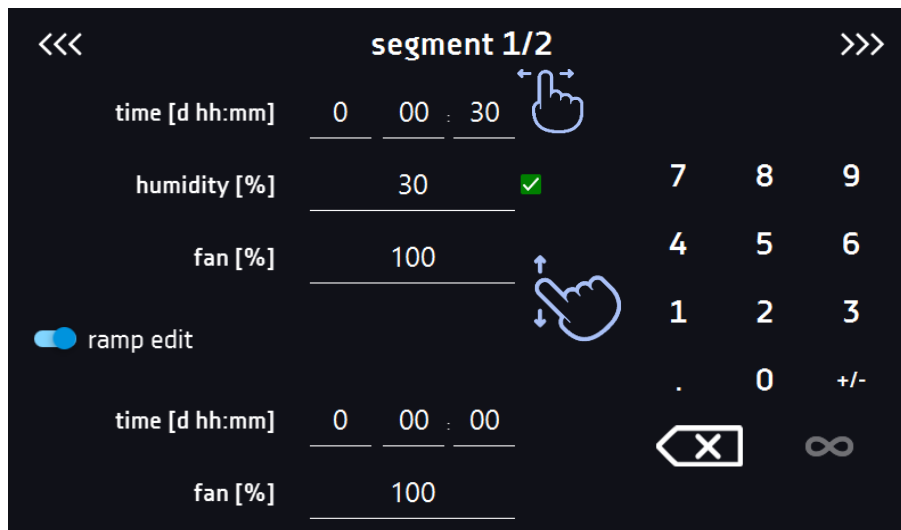

With more parameters, the window can be scrolled up and down.

Figure 28 Program segment edition



The navigation between: segments, program parameters and summary is done by touching the icon  .



If, when editing a program, you automatically return to the home screen or you are automatically logged out, the edited program will not be lost, but saved as a draft (see below).

After configuring all segments, a window with the protection class is displayed (Fig. 29). For class 3.3, you can set the protection temperature.

Figure. 29. Security class 3.3.

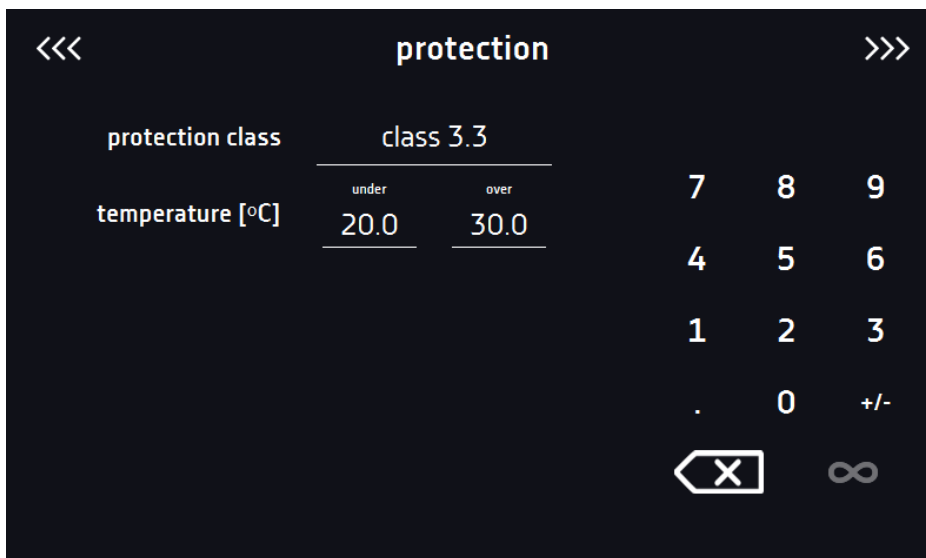

After switching to the program edition, the information about the possibility of continuing changes in the program settings appears (Figure 30).

Figure 30.

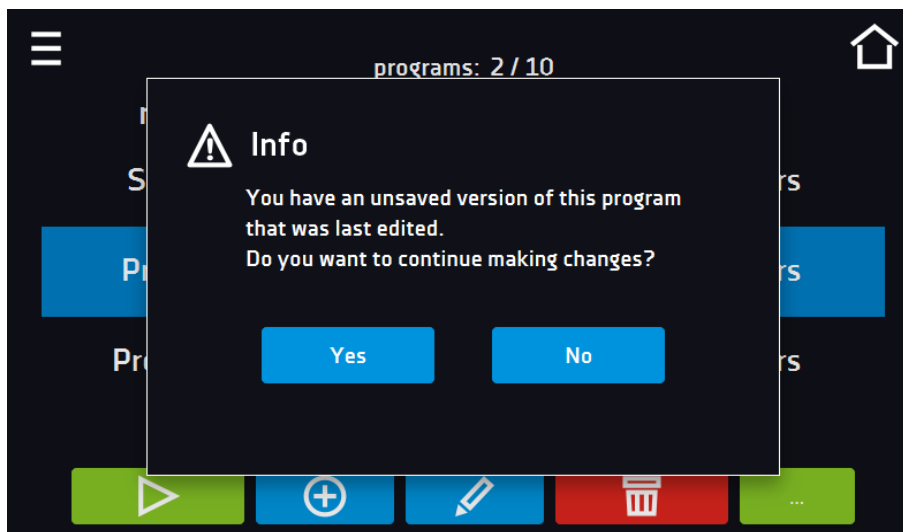

6.7.3. Phytotron FIT (optionally for KK)

The phytotron (FIT) function enables the simulation of day and night: duration and smooth regulation of light intensity.

Phytotron version with illumination panels

Before you start configuration of light parameters, turn on the illumination panel that will be used and configured (applies



to devices with the FIT version in the form of lighting panels). Press  and then  (Figure 31).

Figure 31 Switching on / off the illumination panels



Depending on the capacity of the equipment, 1, 2 or 3 illumination panels can be installed. With several lighting panels, it is not necessary to use them all at the same time. To avoid alarms related to illumination panels which will be removed, select only those that will be used (Figure 32). For example, when the lighting panel will not be used and has been removed from the device, it must be turned off (uncheck the box next to the shelf number). When the illumination panel will be used and inserted into the device, turn it on (mark the box next to the shelf number).

Figure 32 Turning on/off the illumination panel

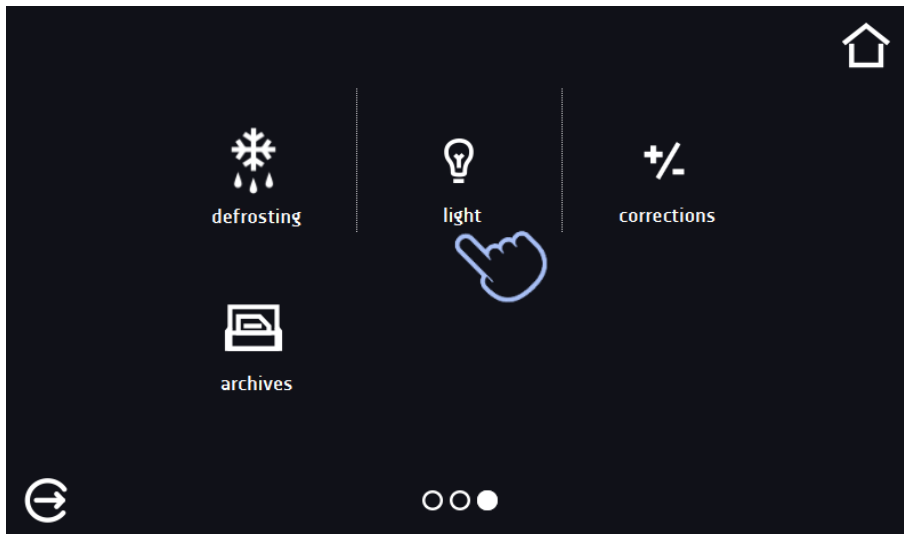

Confirms changes



Cancel the entered changes

6.7.3.1. Equipment with one illumination zone

Equipment with one illumination zone can have fluorescent lamps mounted in: side walls/ doors/ walls and doors/ lighting panel(s). The device with lighting panels has the option of controlling each panel individually, see [Section 6.7.3.2](#). The light intensity can be set every 1%. To set the light intensity, check the "light" box and then enter the value ([Figure 33](#)).

Figure 33 Setting the light intensity value for one illumination zone



6.7.3.2. Equipment with few independently controlled illumination zones (optionally)

The phytotron version with illumination panels can be equipped with an option (additionally paid) allowing independent control of each lighting panel. To set the light intensity in each panel separately:

1. Click the light bulb icon to set the light for each lighting panel in a separate window.
2. To turn on the light in the segment, select the check box ([Figure 34](#)) and then set the intensity value for each turned on panel ([Figure 35](#)).

Figure 34 Turning on the light

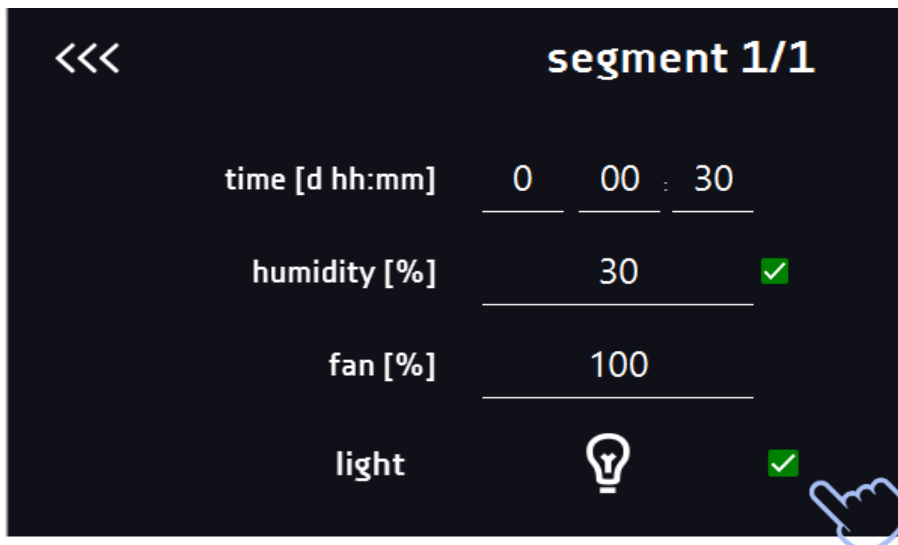

Figure 35 Setting the light intensity in active panels



Confirms and saves the changes



Cancels the entered changes in the segments and goes to program parameters

6.7.4. Summary of segments

In the segments summary (Figure 36) all segments can be seen along with introduced parameters:

- number of segments,
- temperature, duration time, target time of reaching temperature of a given segment,
- fan efficiency

Figure 36 The summary of the segment

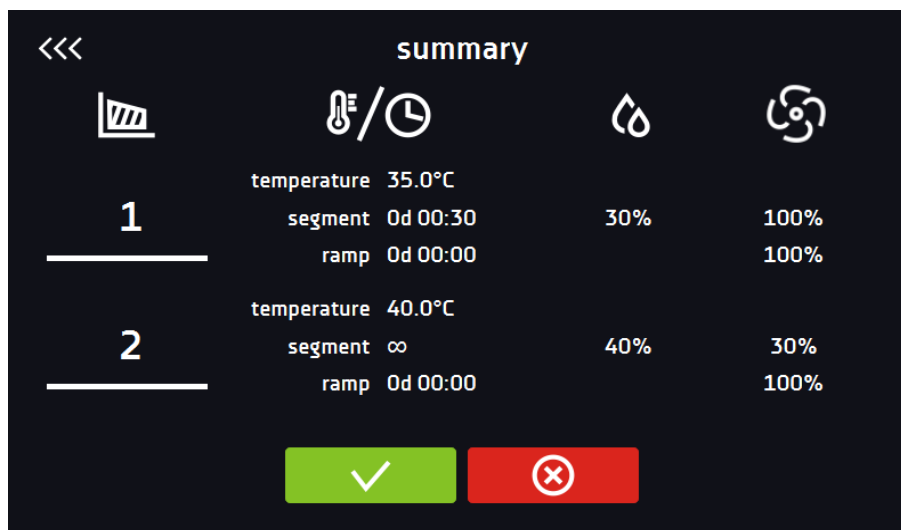

Confirms and saves the changes



Cancels the entered changes in the segments and goes to program parameters



With more parameters, the window can be scrolled up and down.

6.7.5. Protection class

The device is equipped with sample protection – temperature protection which is carried out on the basis of the temperature value measured by an independent temperature sensor, the so-called security sensor. The main aim of sample protection is the protection against uncontrolled rise or fall of temperature. When activated, the relay disconnects the heating / cooling circuit.

Figure 37 Confirmation of protection alarm



Class 3.3 according to DIN 12880 – over and under temperature protection – combination of classes 3.1 and 3.2. - the user programs the protection temperature (over and under) and once it's exceeded, the heaters or compressor will be cut off. When the temperature returns to the allowed range, the device resumes operation.

The set temperature in the segment cannot be higher than the over temperature protection minus 2°C, e.g. the over temperature protection is 50°C, therefore the maximum set temperature in the segment that can be set is 48°C.

6.7.6. Temperature protection

The temperature protection value for protection class 3.3 is:

- bottom protection temperature: maximum +20°C
- upper protection temperature: minimum + 30°C

6.7.7. Priority

Can be set in terms of:

Parameters:

In the program without ramp – the device starts the countdown of the segment time when the set temperature is reached.

In the program with ramp – first, the device counts down the time of the ramp and then proceeds to the segment countdown when the set temperature is reached. Regardless of whether the time of ramp elapsed.



It may happen that the device failed to reach the set temperature within the set time because the reaching time was too short. In such situation the reaching time will be prolonged and the segment's time countdown will start when the set temperature will be reached.

Time:

In the program without ramp – the device starts counting down the segment time when the program is started. Regardless of whether the temperature has been reached.

In the program with ramp – first, the device counts down the ramp time and after its expiry it proceeds to the countdown of the segment time. Regardless of whether the temperature has been reached.



It may happen that the time of reaching was too short and the device failed to reach the set temperature within the set time. Then the countdown of the segment time will start before reaching the set temperature. Thus, the actual time of device operating in the set temperature will be shortened.

6.7.8. Loop

The option is available if the number of segments is equal to 2 or more (maximum 100). When the program finishes the last segment, the device starts the program again from the first segment. You can define if the program should be carried out once (loop: 1) or multiple times (loop: 2 to 255). In order to set the program to be carried out continuously, tick the „∞” option. If the time of the last segment is set to infinity, it will be treated as infinite only in the last cycle. In other cycles it will be treated as 0.

Example:

Loop:3

segment1: temp. 20°C, 60% RH, time 2 h

segment2: temp. 30°C, 70% RH time 2 h,

segment3: temp. 50°C, 80%, time „∞”

The device will run segment1 and segment2 three times and then will go to segment3 which will last indefinitely.

6.8. Starting the program

The created program can be started in two ways:

6.8.1. The first way



- Go to the main menu  and press the icon „programs”  (Figure 38).
- Then select the program you want to activate and press „start” button  (Figure 39).

Figure 38 Main menu

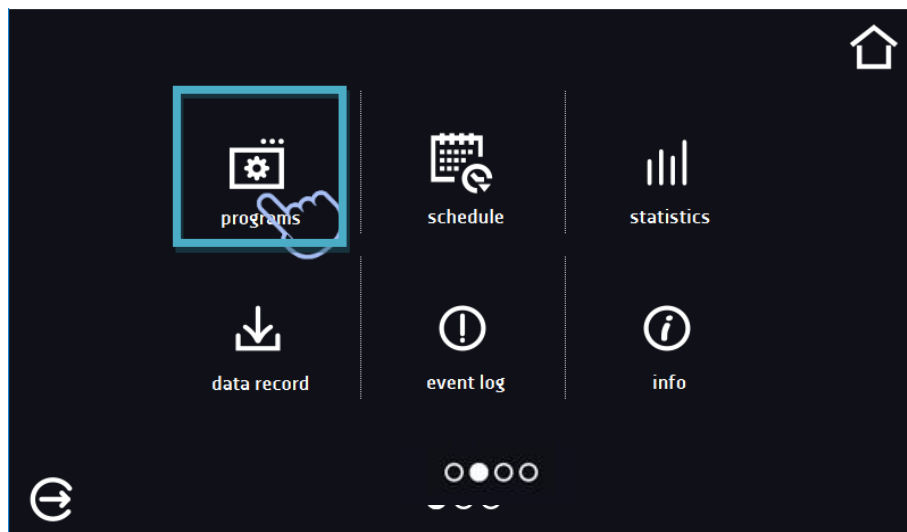
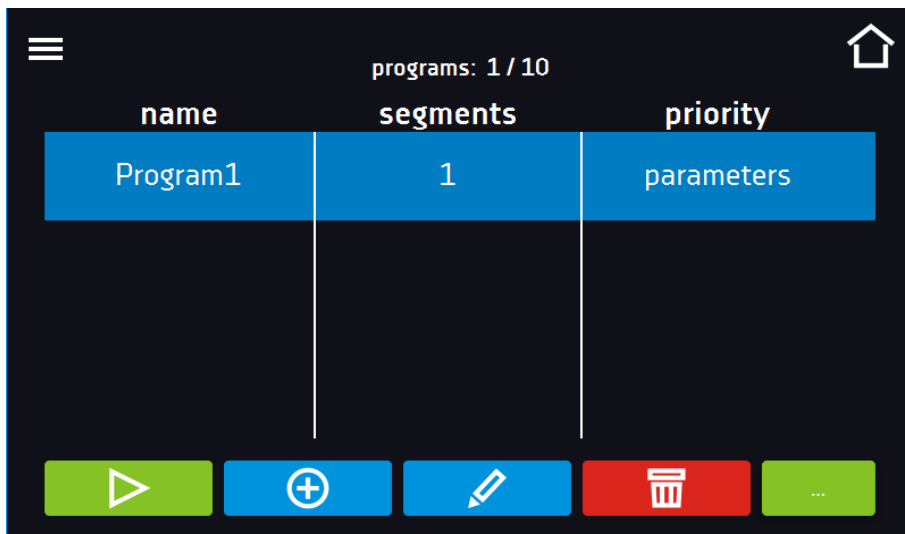

Figure 39 Program management menu







If the program is running, the symbol  appears next to the program name on the list. The symbol  means that the program has been edited, but the changes have not been confirmed (Figure 40).

Figure 40 List of programs with the selected status

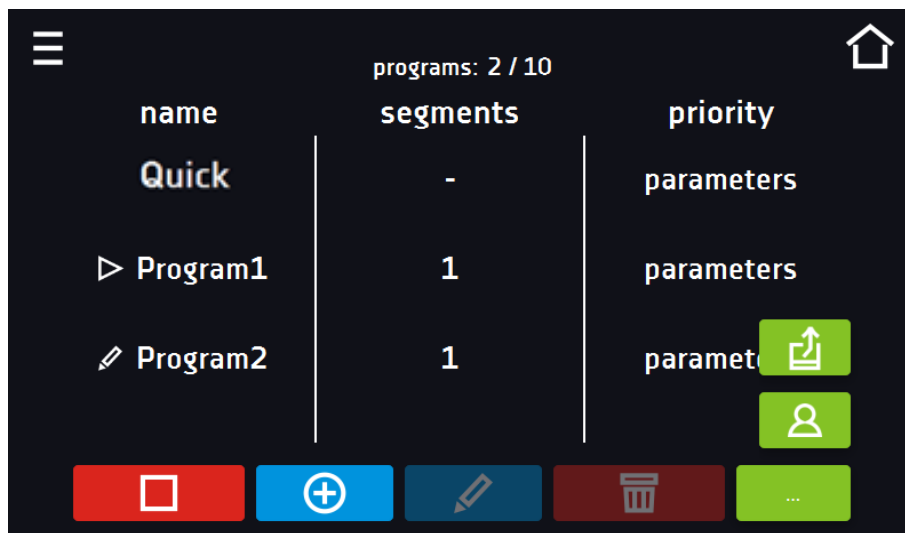

6.8.2. The second way

- In the main screen press the icon in the upper right corner  (Figure 40).
- In the upper left corner press „PROGRAM“
- Select the program you want to start (Figure 41). You have two additional options to start the program:



Immediate start of the program.



Scheduled program start according to the set date and time.

Figure 41 Main screen

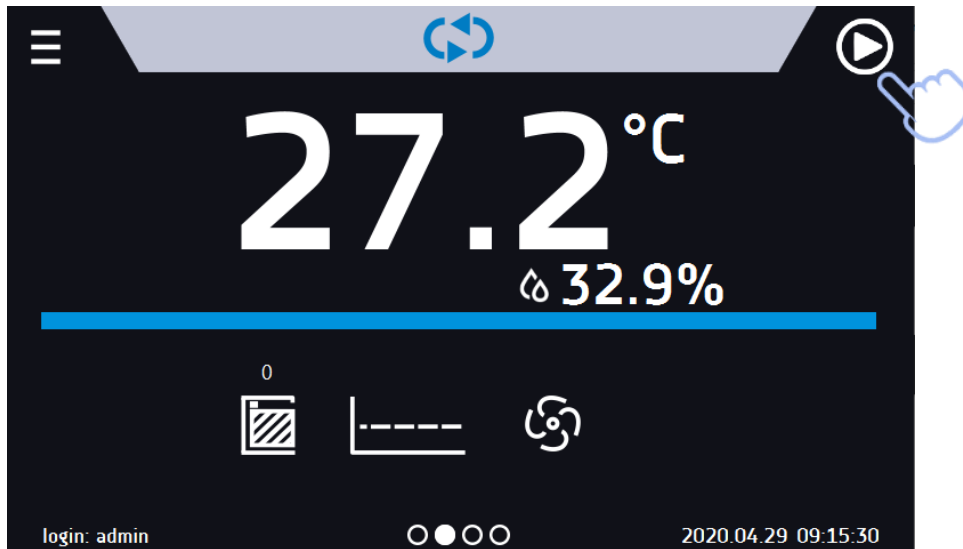
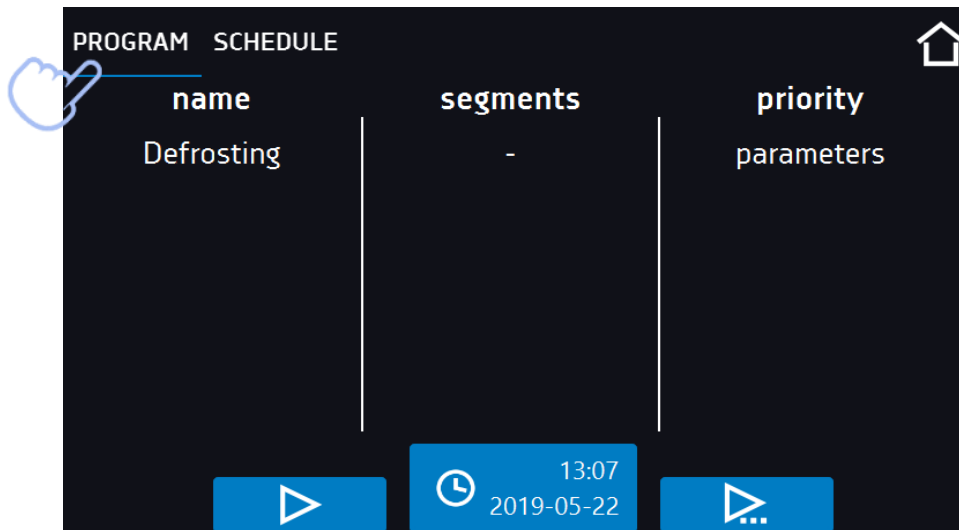



Figure 42 Selection and launch of the program



 A delayed start of backdated program is possible (up to 7 days back). This is possible for the programs with time priority. Program segments that would last from the back date to the current date will be skipped.

If the program is running, the symbol  appears next to the program name on the list



6.9. Quick change of parameters

 You cannot make a quick change (of time / temperature) in a running program that belongs to another user. Information about the program owner can be found in the information panel (lower left corner).



Although the ramp time has been included in the program, the Quick Change of parameters will take place immediately while the temperature is being reached.

6.9.1. Quick change of set temperature

In order to quickly change the value of set temperature of a running program, press the icon  in the main screen (Figure 43). The value of the temperature should be selected by scrolling the list up or down (Figure 44). Click  to confirm the change.

The temperature can't be higher than the over temperature protection -2°C and lower than the under temperature protection +2°C.

Figure 43 Quick temperature change - selection

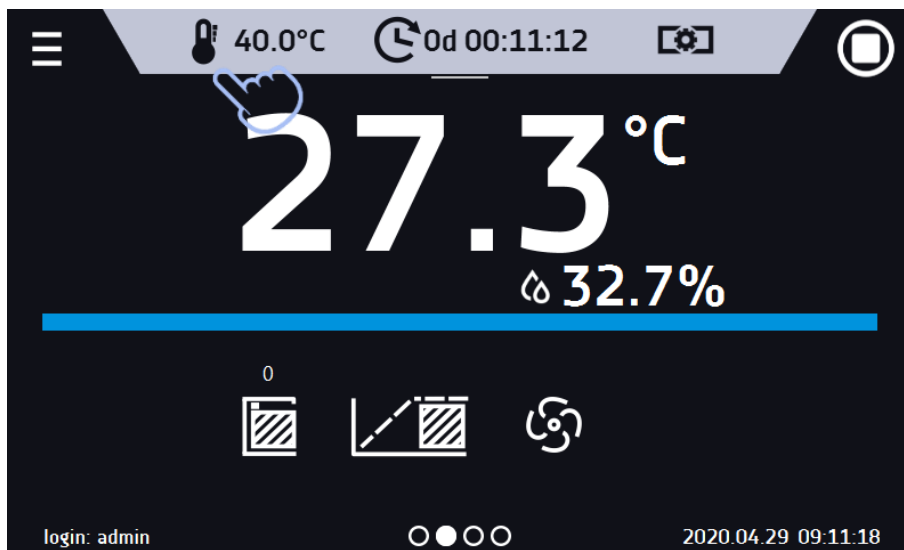
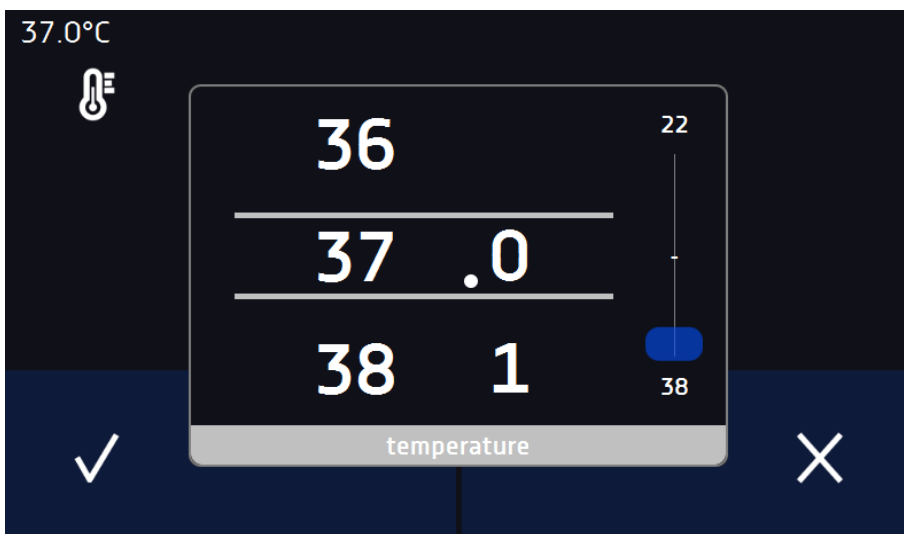

Figure 44 Quick temperature change - setting the value



6.9.2. Quick change of set humidity



In order to quickly change the set humidity of a running program, press the icon  in the main screen (Figure 45). Choose the humidity value by scrolling the list up or down (Figure 46). Click  to confirm the change.

Figure 45 Quick change of humidity - selection

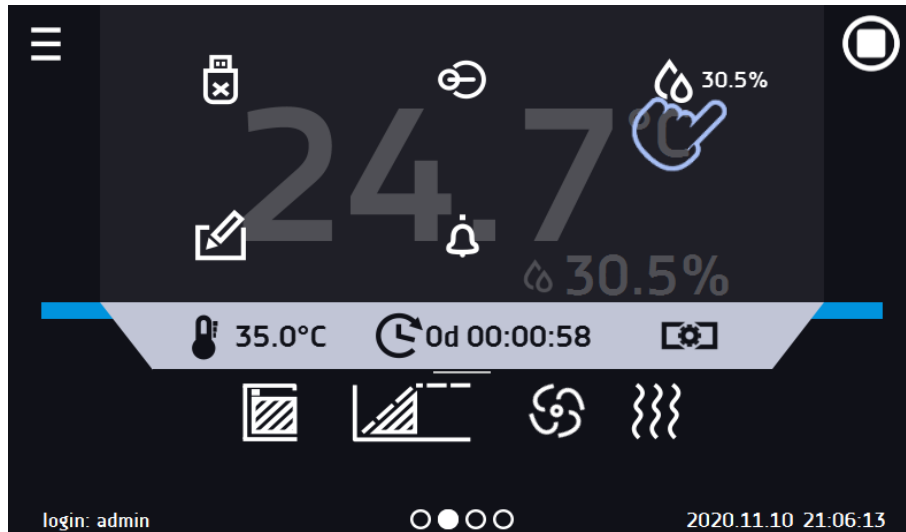
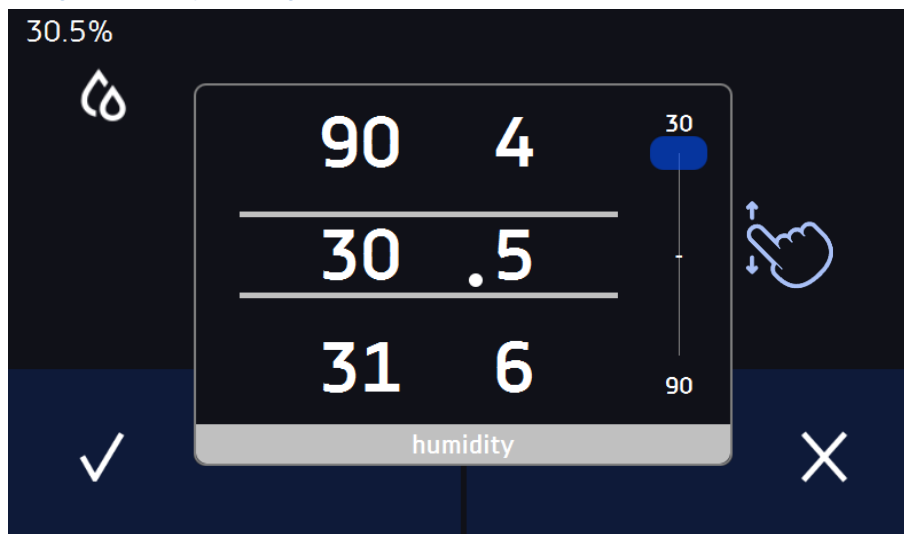





Figure 46 Quick change of humidity - setting the value



6.9.3. Quick change of set time

In order to quickly change the duration time of a running program, press the icon  in the main screen (Figure 47). Select the number of days, hours and minutes by scrolling the list up or down (Figure 48). Click  to confirm the change. To set the continuous work press .

To change the way of displaying the time, press::



– to display the elapsed time



– to display the remaining time

To change only the way of displaying, you do not have to confirm it by .

Figure 47 Quick change of the set time - selection

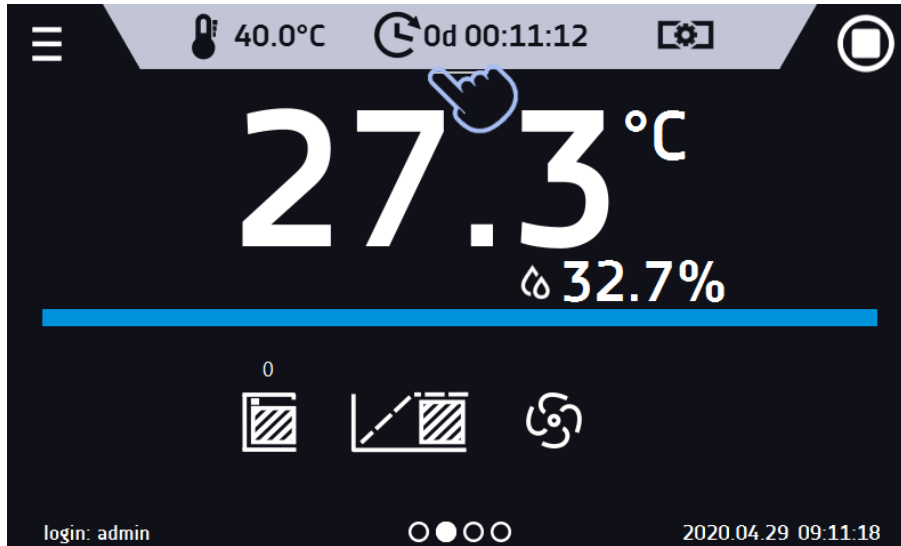
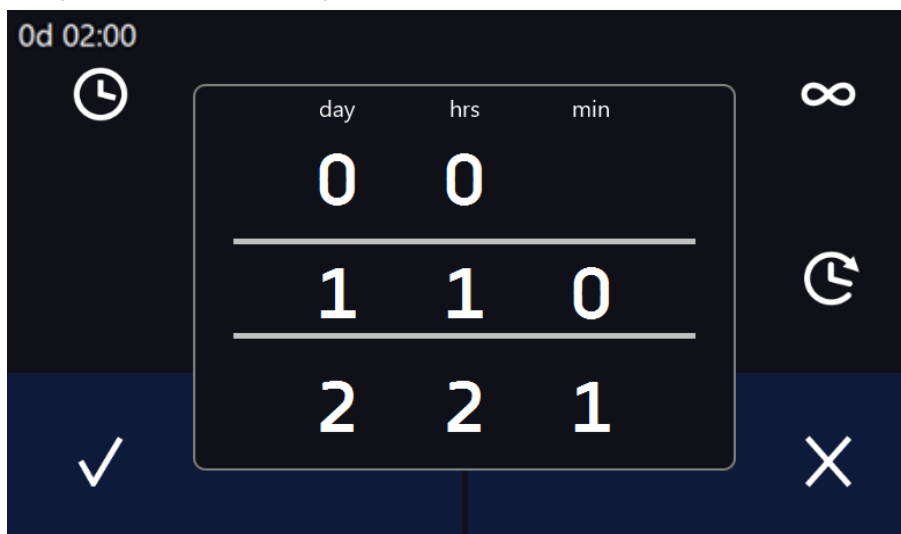

Figure 48 Quick change of the set time - setting the value



6.9.4. Quick change of fan efficiency



In order to quickly change the fan efficiency, press the icon  in the main screen (*Figure 49*). The value should be selected by scrolling the list up or down (*Figure 50*). Press  to confirm the change.

Figure 49 Quick change of fan efficiency

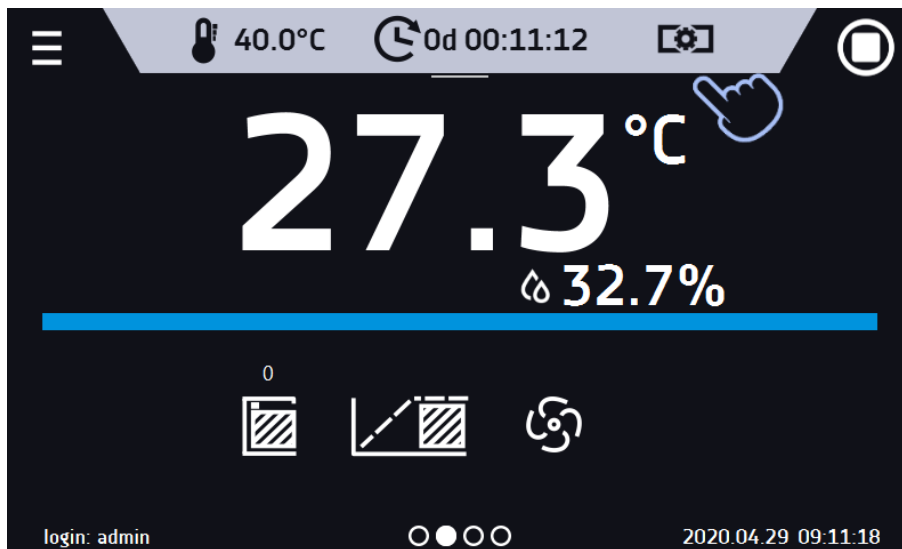
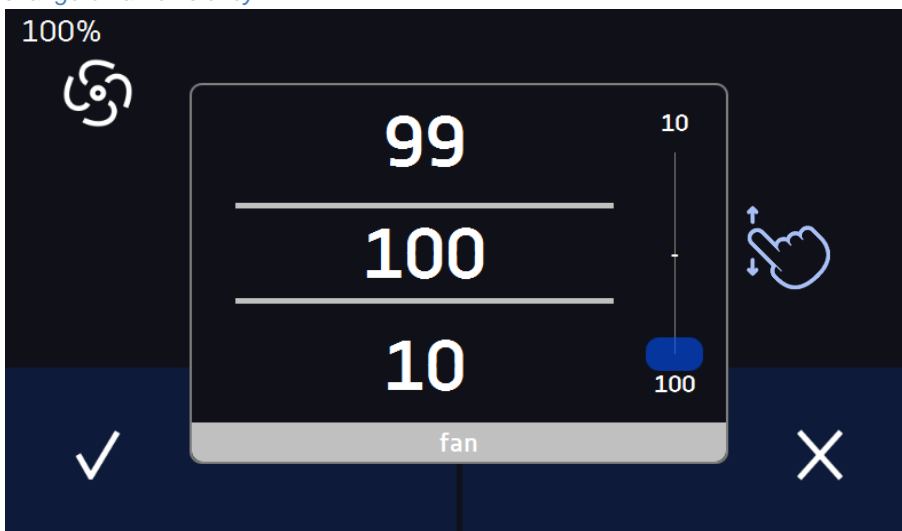



Figure 50 Quick change of fan efficiency



6.10. Schedules

The option allows creating a list of programs to be implemented in a given time. You can create several independent schedules. The schedules window contains a list of all created schedules of the logged-in user (Figure 51).



Before you start creating a schedule, you must create programs that you want to include in it.

On the upper part of the screen there is information about the number of created schedules / the maximum number of schedules to be created (1/10).

Figure 51 List of schedules

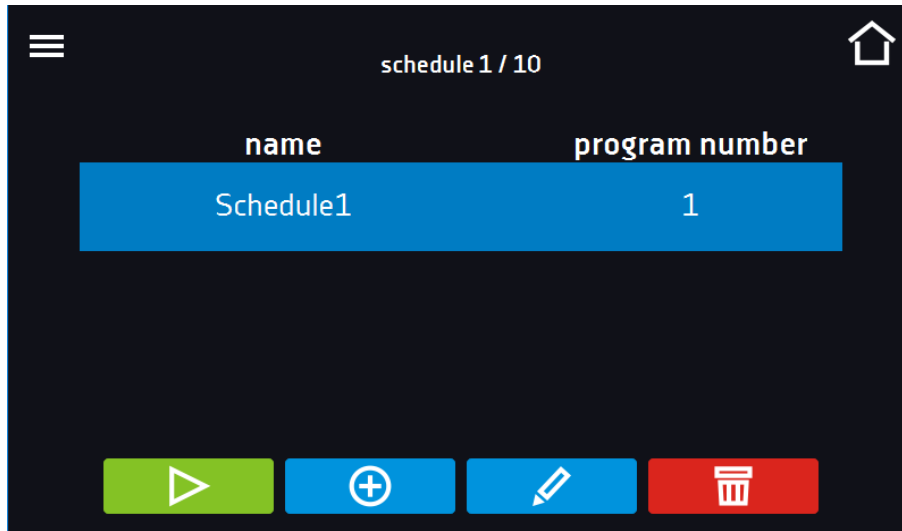

Start the schedule



Stop the schedule



Add the schedule



Edit the schedule



Delete the schedule

6.10.1. Creating / editing a schedule









To create / edit a schedule, press the button  or . The panel with schedule parameters will appear on the screen (Figure 52). Press "Schedule" and use the keypad to enter the schedule name. The schedule may consist of up to 10 programs.

Figure 52 Creating / editing a schedule

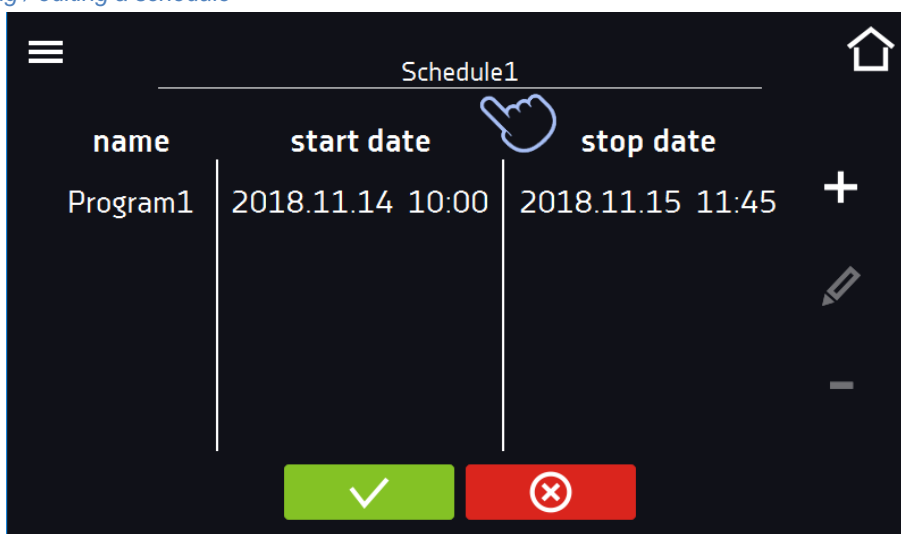

-  Add a new program to the queue (program must be previously created)
-  Edit and make changes to the selected position
-  Delete the selected position from the list
-  Save the schedule
-  Cancel introduced changes



After pressing  (Figure 53) or  a window appears allowing you to select the program and the date and time of its start and end (Figure 54).

Figure 53 Adding a program to the schedule



Select a program from the drop-down list and press on the field next to the inscription "program" (Figure 54). Information about the selected program will be displayed (Figure 55): number of segments, number of cycles, priority, temperature protection, upper protection, lower protection. This is only a preview of the parameters - it is not possible to change them in this window.

Figure 54 Selection of the program

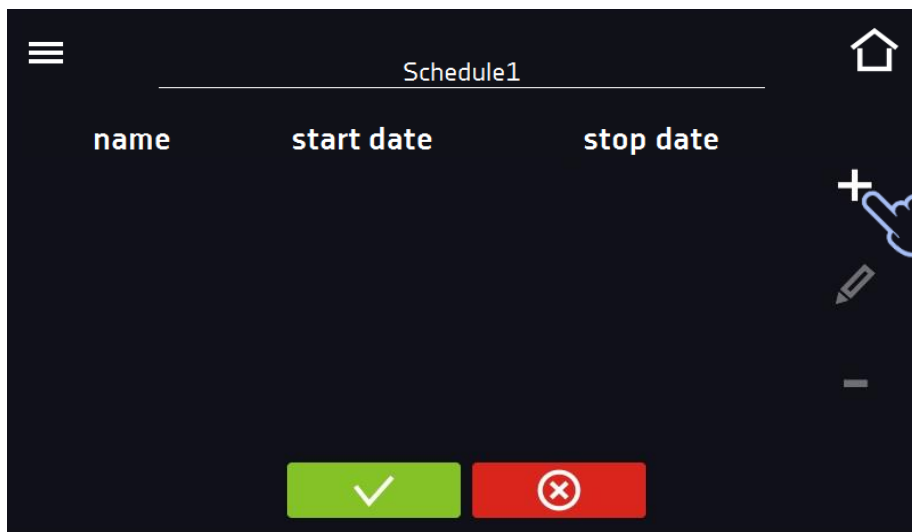
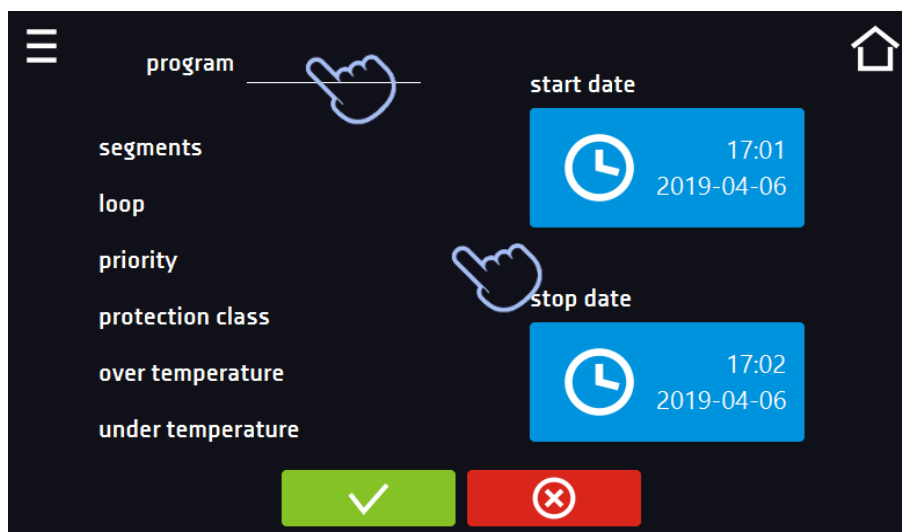
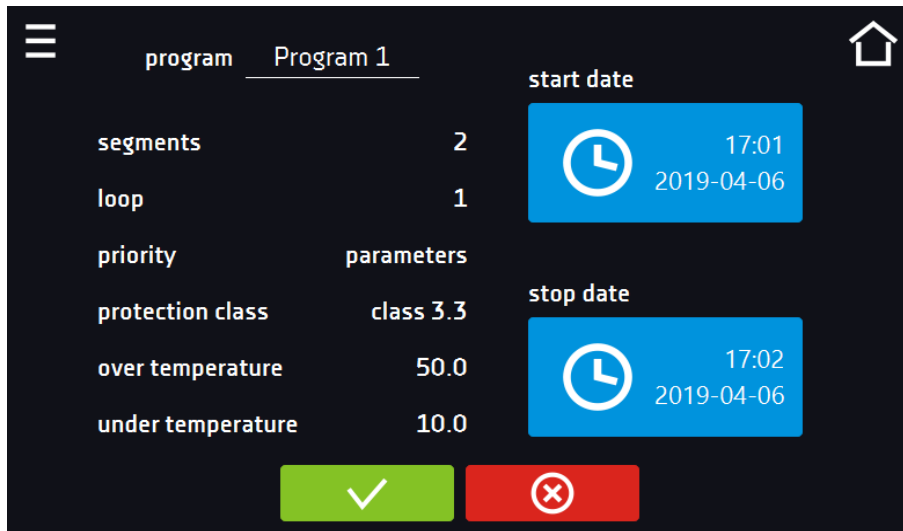
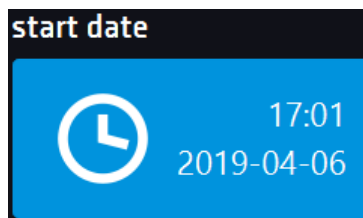

Figure 54 Information about the program



Press the 'start date' field and then set the date and time of program start.



Press the 'stop date' field and then set the date and time of the program end.

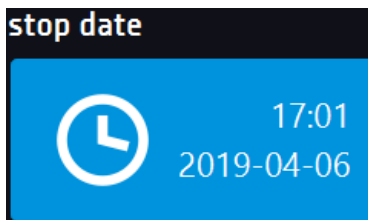

 You can assign up to 10 programs to one schedule. In total you can create ten schedules.

When creating a schedule, consider the following restrictions:

- the start time of the first program on the list cannot be earlier than the current date and time,
- the start time of the next program on the list cannot be earlier than the end time of the previous program,
- the program end time cannot be later than the start time of the next program,
- the end time of the next program does not have to coincide with the start time of the next one, there may be a break between them,
- if the program is not fully completed (due to setting a too short time of a schedule), it will be interrupted.

 When choosing time intervals, consider whether they are long enough for the selected program to be implemented. The duration of the program can be affected by: ambient conditions, samples and the program carried out immediately before it.

6.10.2. Starting a schedule

The schedule can be started in two ways:

6.10.2.1. The first way



- Press the icon of the main menu  and then press the icon „schedule”  (Figure 56).
- Then select the schedule you want to activate and press the start button.  (Figure 57).

Figure 56 Main menu

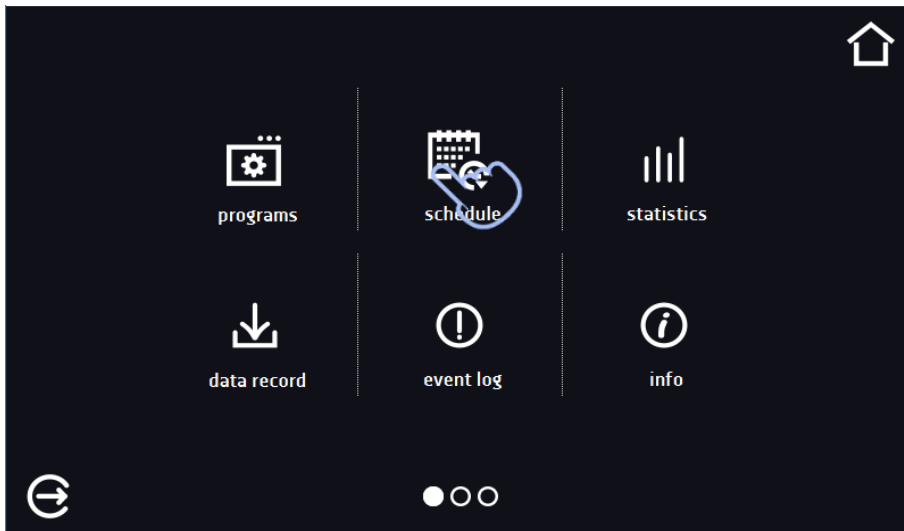
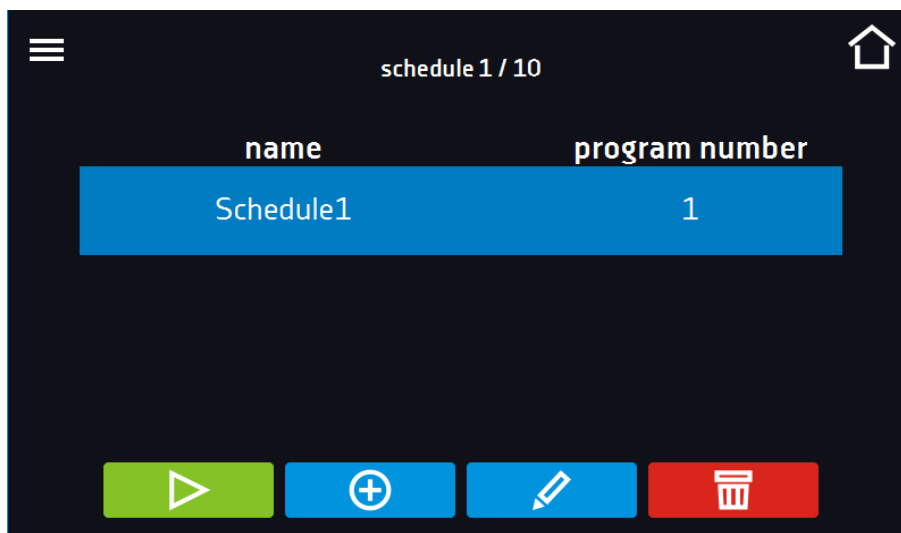



Figure 57 List of schedules





Start the schedule

6.10.2.2. The second way

- In the main screen press the icon  (Figure 58), then press the SCHEDULE inscription. The schedule selection window will be displayed (Figure 59).
- Then select the schedule you want to activate and press the button .



Please note that it is not possible to run a schedule in which all parameters refer to the past time.

Figure 58 Main screen

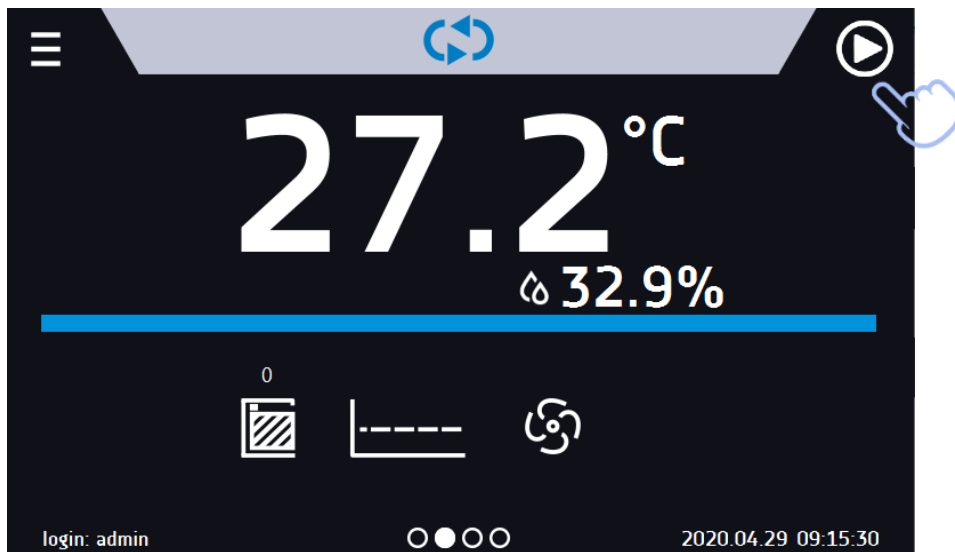
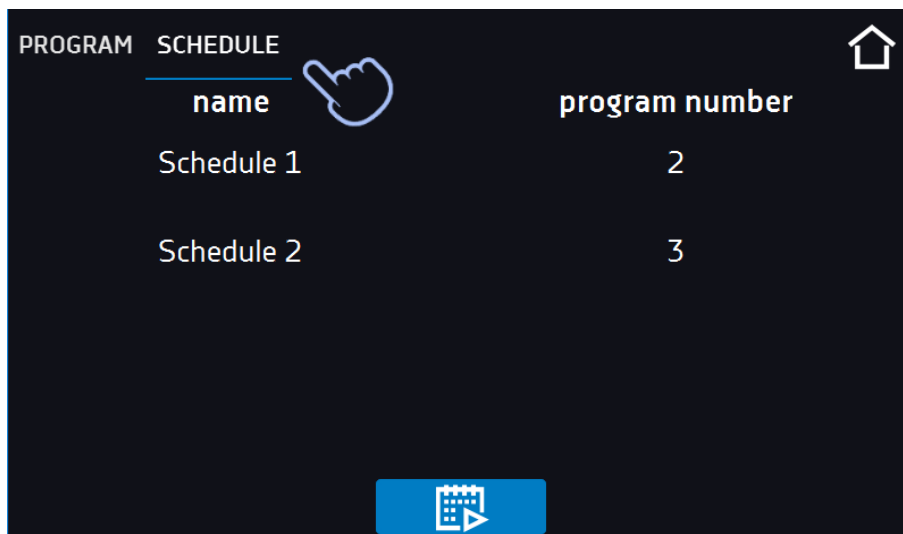



Figure 59 Selection of the schedule



6.11. Statistics

Go to the main menu  and press the icon . This panel (Figure 60) displays statistics of the currently running program or program that has ended. Statistics are calculated separately for each segment. Data logging for calculation starts after 30 seconds from reaching the set temperature in the segment. Further data is registered every 1 minute.

The following information is available:

- **set temperature [°C]** – set temperature in the segment,
- **minimum temperature [°C]** – the lowest recorded temperature,
- **maximum temperature [°C]** – the highest recorded temperature,
- **average temperature [°C]** – average temperature,
- **set humidity [%]** – set humidity in the segment,
- **minimum humidity [%]** – the lowest recorded humidity,
- **maximum humidity [%]** – the highest recorded humidity,
- **average humidity [%]** – average humidity,
- **segment** – status of the segment:
 - **in progress** – currently running segment (data is being constantly updated),
 - **finished** – the segment has been completed,
 - **interrupted** – the segment was interrupted by the User before the set time has elapsed,
- **segment 1/2** – the number of the currently overlying segment / number of the currently performed or completed segment. Navigating between the segments is done by swiping your finger up or down.
- **loop 1/1** – the number of the currently overlying cycle / number of the currently performed or completed cycle. Navigating between the cycles is done by swiping your finger left or right.

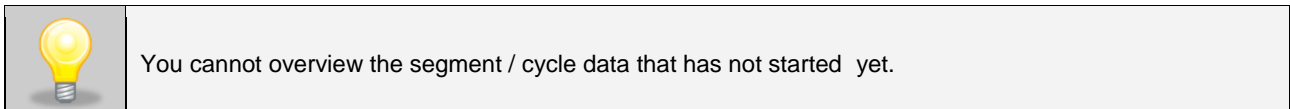
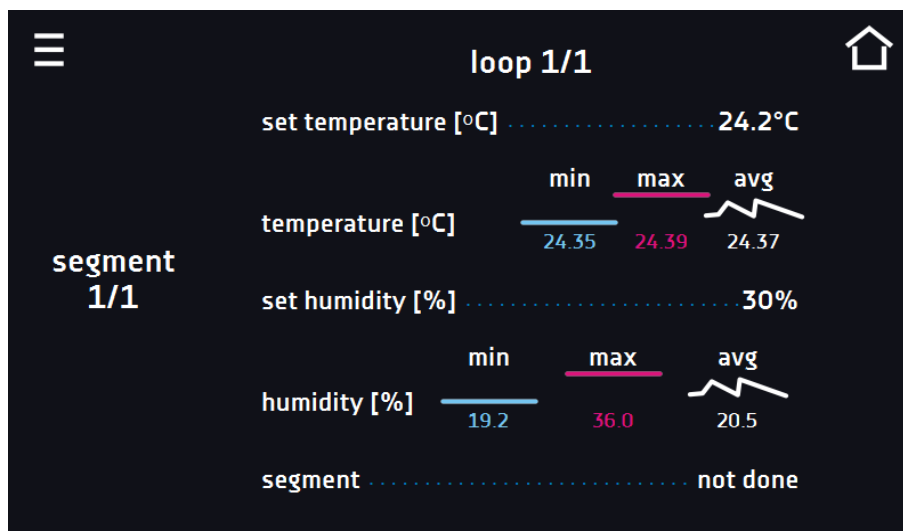



Figure 60 Statistics



6.12. Data record

Go to the main menu  and press the icon . Data record window (Figure 61) contains the following information:

- time and date of sample registration [date],
- temperature value measured with the main sensor in the chamber [temp.],
- humidity value [%] measured with the humidity sensor in the chamber [hum.]

It is possible to register 10 000 data records for the max period of 12 months. If all the memory cells are full, the oldest ones are overwritten. The data appears in the table in the order they were added, not in chronological order by the date. The most recently added record is at the top. The samples are only registered when the program is running. The frequency of registration depends on the program parameters settings.



 When opening the data record, all data is downloaded. If the data download is interrupted by the user, press  to continue downloading of the rest of the data.

Figure 61 Data record



date	temp.	hum.	status
2020.04.29 23:47	26.90	32.5%	set temp.
2020.04.29 23:37	26.94	32.4%	set temp.
2020.04.29 22:36	25.82	34.0%	ramp
2020.04.29 20:59	25.49	31.4%	ramp
2020.04.29 20:49	25.53	30.8%	ramp
2020.04.29 20:39	25.61	30.2%	ramp
2020.04.29 20:39	25.61	30.2%	ramp
2020.04.29 20:29	25.66	29.7%	ramp

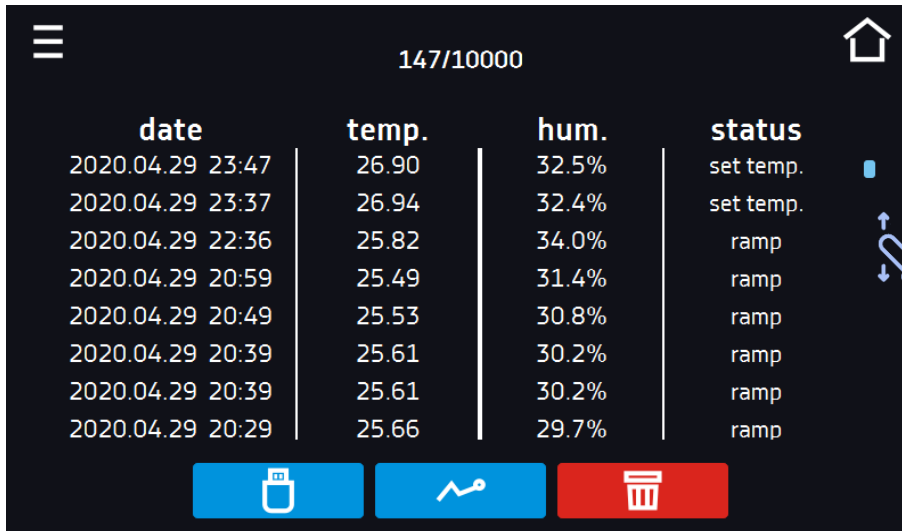

Press to continue downloading data



Recording data onto the USB flash drive. .csv files are available - separated by semicolon when opening e.g. with a spreadsheet, .plx - opening with the Lab Desk application



Before removing the USB flash drive from the USB port, it must be unmounted, see [Section 5.5](#).



Displaying data as a graph, see [Section 6.12.1](#).



Deleting data. Users with Super Admin privileges can delete all data, including those registered by other users ([Figure 62](#)).

If there is a lot of data, a progress bar appears on the display:

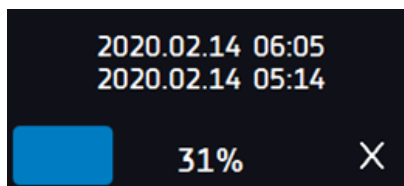



Figure 62 Deleting data

 **Deletion of data**

Are you sure you want to delete data?
This operation can not be undone!

✓ ✕

6.12.1. Graph

A graph can be generated from the data stored in the data register (Figure 63). The time during which the graph opens depends on the number of saved samples data. If the unit is equipped with additional sensors, press the selected graph twice.

Figure 63 Temperature graph

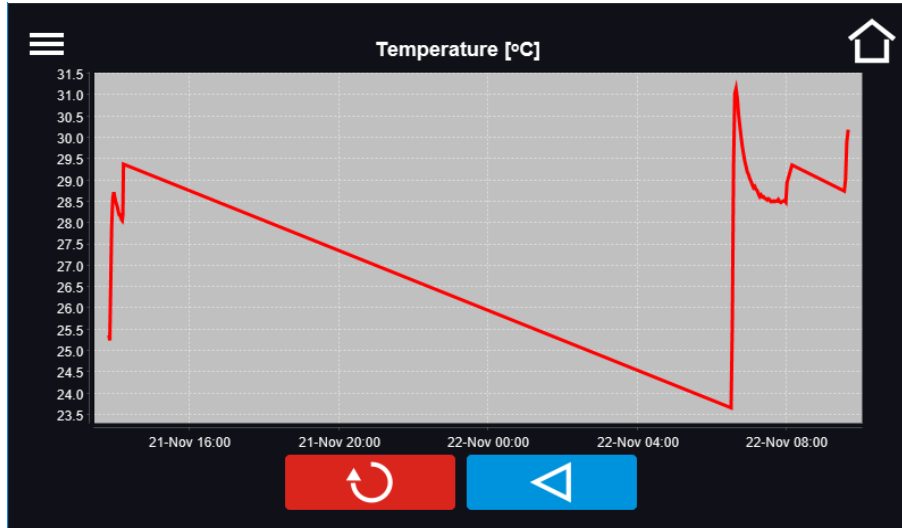

Returns to displaying the entire chart (undo all magnifications) / returns to the list of charts.



Returns to data register

Figure 64 Humidity graph

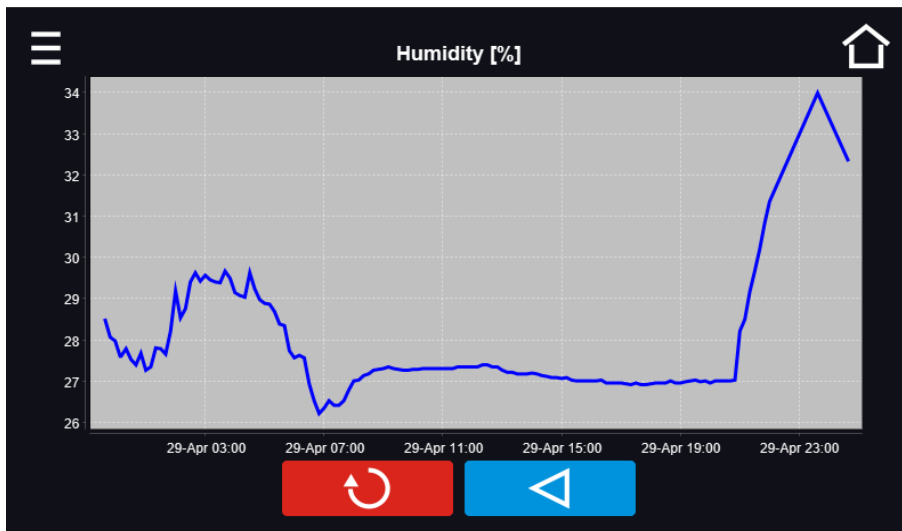

Returns to displaying the entire chart (undo all magnifications) / returns to the list of charts.



Returns to data register

Figure 65 Temperature and humidity graph

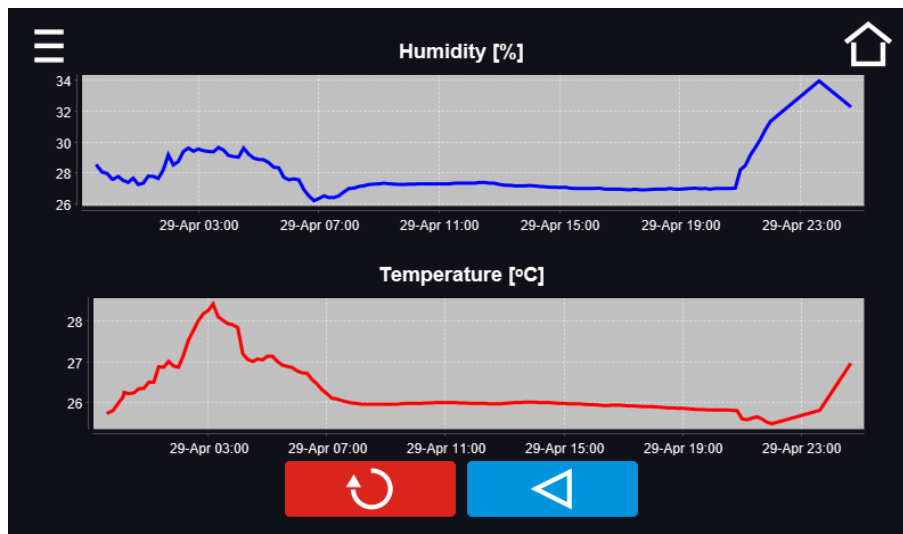

Returns to displaying the entire chart (undo all magnifications) / returns to the list of charts.



Returns to data register



The opening time of the chart depends on the number of saved data samples. The greater the number of saved samples, the longer this window will open.

You can enlarge a fragment of the chart. Press the graph anywhere and drag to the right and down simultaneously (Figure 66) - enlarge in the same way as it is done on a smartphone. Swipe left to return the chart to normal size.

Figure 66 Enlarging a part of the chart

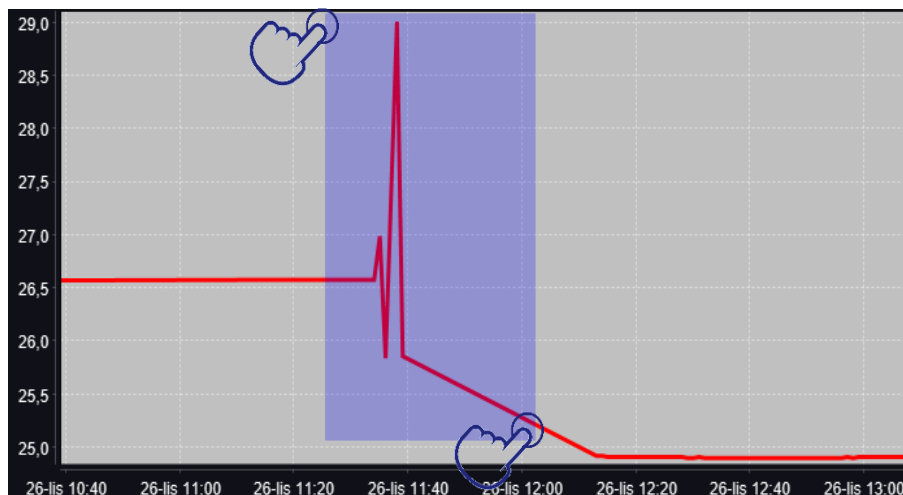

6.12.2. Data storage directly on a USB flash drive

The saved data (temperature and / or humidity, date and time) can be saved directly on a connected USB flash drive. To do this, enable the option of saving data, see point 6.16 and. The USB flash drive must be connected to the USB socket located on the front of the equipment.

The date / time, temperature of the sensor installed in the chamber and indications of additional sensors in the unit (humidity, additional temperature sensor) are saved to the file. The frequency of saving to the file is equal to the frequency

of saving the data in the register set in the program, see section [6.7.1. Creating / editing a program](#) (saving interval to the data register). Few comments can be found below:

- saving to the file takes place only when the program is running,
- data register is continued after power is restored,
- during registration, the USB flash drive can be removed but it is necessary to unmount it in the main window on the upper menu bar, see section [5.5. USB port](#),
- registration is continued after reinserting the USB flash drive,
- a folder with the name consistent with the serial number of the device is created on the flash drive, all files are saved in it. The files are saved in the csv format (separated by semicolons), which can be read in a spreadsheet or notebook

	A	B	C
1	date	temp.	status
2			
3	23.03.2022 11:06	25.04°C	wait
4	23.03.2022 11:07	25.04°C	ramp
5	23.03.2022 11:08	25.04°C	ramp
6			

- the current measurement is saved to a file named measurements.csv,
- if the size of the current file exceeds 513 kB or the calendar month is changed, the current file is named in the format yyyy-mm_ measurements_0.csv, where 0 means the file number in the month, e.g. 2021-05_ measurements_0.csv

6.13. Event log

Data available for the following users ([see Section 6.15 Users](#)):

- **Super Admin** who can overview, download to USB flash drive and delete all data,
- **Admin** who can overview, download to USB flash drive all data,
- **User** who can only overview all data.



Go to the main menu  and press the icon . The window displays information about registered events, alarms and errors.

Figure 67 Event log



date	name	code
2020.11.10 21:04	Program Stop	2.01.0.1.008
2020.11.10 21:03	Program Start	2.01.0.1.007
2020.11.10 21:03	Program Stop	2.01.0.1.008
2020.11.10 21:03	Program Start	2.01.0.1.007
2020.11.10 21:03	Program Stop	2.01.0.1.008
2020.11.10 21:03	Program Start	2.01.0.1.007
2020.11.10 14:13	Program saved	2.01.0.1.022
2020.11.10 14:13	Program deleted	2.01.0.1.023
2020.11.10 14:12	Program updated	2.01.0.1.024

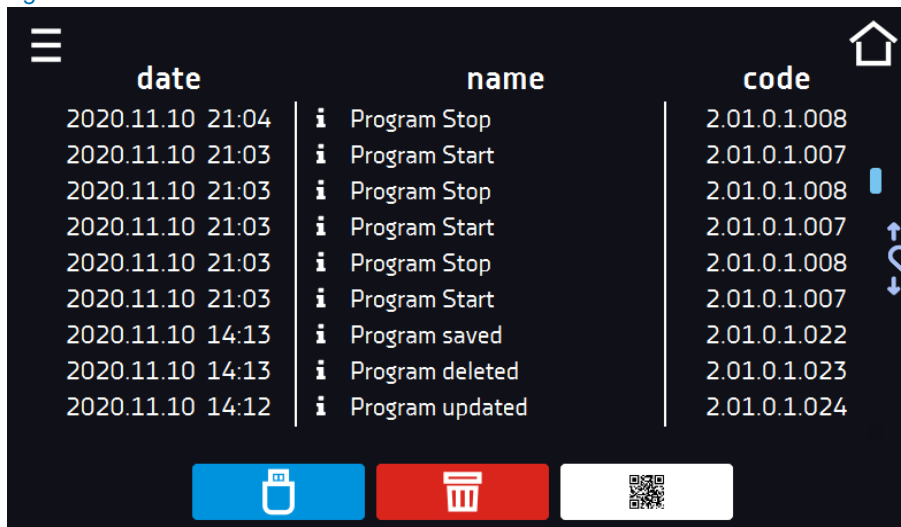

Recording data onto the USB flash drive. .csv files are available - separated by semicolon when opening e.g. with a spreadsheet, .plx - opening with the LabDesk application



Before removing the USB flash drive from the USB port, it must be unmounted, see [Section 5.5](#).



Deleting data.



QR code – opens smart4lab.eu (in the "Support" tab there are explanations of some of the

information appearing in the event log). Press the symbol  and enlarge the code QR, and then scan it with your smartphone.

Figure 68 QR code





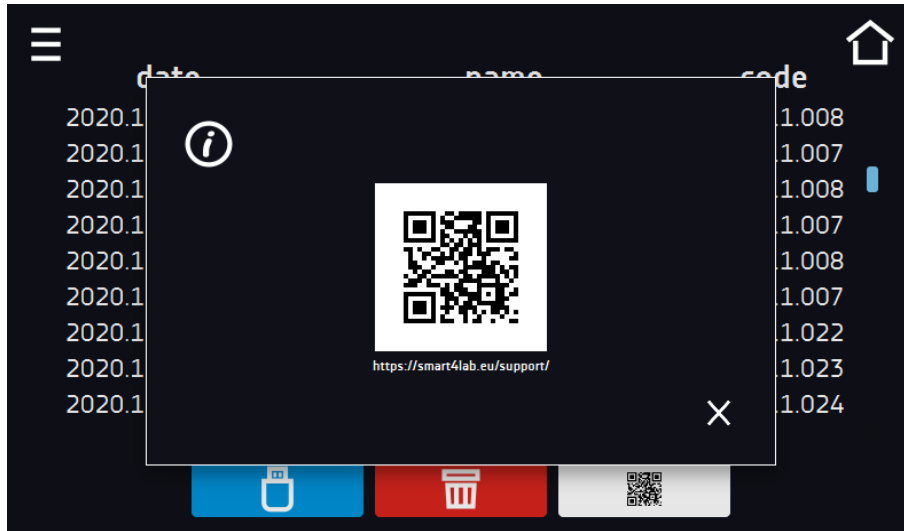

The events in the event log are sorted chronologically. However, it may happen that the event "Program restarted" will not be displayed according to the chronology but the date and time of the event will be correct. This is not an error.



Before removing the USB flash drive from the USB port, it must be unmounted, see [Section 5.5](#).

Information signs in the event log:

-  Information event
-  Message entered by the user
-  Alarm event
-  Error
-  Warning

Possible events:

Program Start	starting the program
Program Stop	stopping the program
Program Edit	changing the program parameters
Program End	program is completed
DeviceOn	the device is switched on (on the main switch)
DeviceOff	the device is switched off (on the main switch)
Door opened	the door is opened
Open door alarm start	open door alarm has been activated
Door closed	the door is closed

Instruction manual KK, KKS SMART PRO

Open door alarm stop	open door alarm has been deactivated
Program Restarted	program has been resumed after power failure
Under Protection Start	under-temperature protection has been activated
Under Protection Stop	under-temperature protection has been deactivated
Upper temp. alarm Start	over- temperature protection has been activated
Upper temp. alarm End	over- temperature protection has been deactivated
Date/time change	date/time has been changed
Lower temp. alarm Start	activation of the alarm of exceeding the temperature below the set temperature
Lower temp. alarm End	deactivation of the alarm of exceeding the temperature below the set temperature
Upper temp. alarm Start	activation of the alarm of exceeding the temperature above the set temperature
Upper temp. alarm End	deactivation of the alarm of exceeding the temperature above the set temperature
Lower RH Alarm Start	activation of the alarm of exceeding the humidity below the set value
Lower RH Alarm End	deactivation of the alarm of exceeding the humidity below the set value
Upper RH Alarm Start	activation of the alarm of exceeding the humidity above the set value
Upper RH Alarm End	deactivation of the alarm of exceeding the humidity above the set value
Deleted Measurement	user measurements have been deleted
Deleted All Mesurement	all measurements have been deleted
User added	new user has been added
User updated	user has been changed
User deleted	user has been deleted
Program saved	new program has been saved
Program deleted	program has been deleted
Program updated	program has been updated
Time Zone Changed	in the time settings the time zone has been changed
Temperature Correction Changed	main sensor temperature correction has been changed
Humidity Correction Changed	humidity sensor correction has been changed
Emergency stop of the program	the program has been automatically stopped – there was a situation that didn't allow the program to be continued. PLEASE CONTACT THE SERVICE
Defrosting Start	starting the defrosting process
Defrosting Stop	stopping the defrosting process
tank low level Start	means low water level in the tank, fill up the water in the tank to ensure proper humidity maintenance (only KK models can be equipped with a water level sensor)
tank lo level Stop	the water level in the tank has returned to the correct level (only KK models can be equipped with a water level sensor)
Power Fail Start	power failure / device fuse blown out.
Power Fail Stop	power resumed, returned to maintain program parameters
User login	date and time of login
User logout	date and time of logout



Quick note

To view message details, click **User Message**. In this window (Figure 69) you can see the content of the message, the name of the user who entered it and the name of the program during which the message was written.

Figure 69 Details of user's message

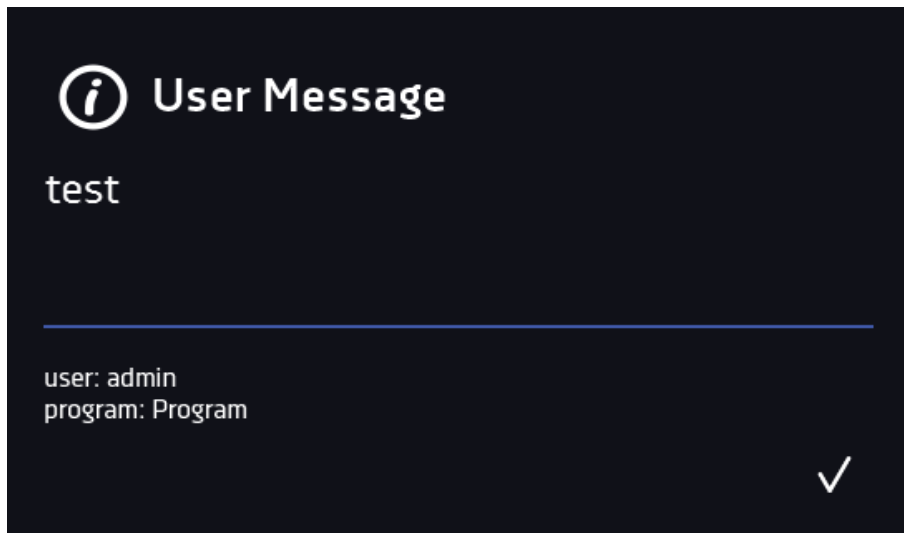



6.14. Info

Go to the main menu  and press the icon . The panel contains the following information:

- name of device,
- temperature range of the device,
- humidity range of the device,
- serial number of the device,
- Software version,
- manufacturer's address,
- manufacturer's website,
- QR code

Figure 70 Info window (example)



Press icon  to save the "Download" folder (with instruction manual) on the USB flash drive. After inserting the flash drive into USB port wait few seconds until the information "Flashdrive connected" will appear on the display - for more information go to the [Section 6.1](#). Press the icon  to write the service data on the USB flash drive – contact the service for more information.

Press  to go to the main screen. If a USB flash drive is connected to the device, when entering the "Info" panel, a proposal to save configuration file will appear ([Figure 71](#)). This file is used to create an offline program in the Lab Desk application.



Figure 71 Saving configuration file



6.15. Users



Go to the main menu  and press the icon . In this panel ([Figure 72](#)) you can add a new user, edit an existing one or delete it.

Figure 72 Users list

login	programs	type
admin	10	super admin
a	10	super admin



Adding a new user



Editing selected user



Deleting selected user - his programs and data register will be deleted with the user.

At the top of the screen (Figure 71) you can see information about:

- **users:** number of created users / total number of users to create (users 2/5),
- **available programs:** the number of free programs to be assigned to users.

6.15.1. Creating / editing a user

To add or change user settings, press the button  or , a panel with user data will be displayed (Figure 73).

You have to enter:

- **login** – user name,
- **password** – account password,
- **password confirmation** – you must enter the password again to confirm it,
- **type** – account type (Super Admin , Admin, User), for more information see [Section 6.15.2.](#),
- **programs limit** – number of programs that can be created by the user / number of available programs (it's not possible to set a limit to the User).

Figure 73 Editing a user



Confirms and saves the user



Cancels introduced changes and returns to the users list



The device can have maximum 5 users. There are 40 programs available which can be freely distributed among users.

6.15.2. Account types and their limits

Three different types of users (accounts) are available: Super Admin, Admin, User. Each user has their rights and limitations described below in the [table 1](#).

Table 1. Right and limitations of the users.

	Super Admin	Admin	User
Creating programs	✓	✓	X
Editing programs	✓	✓	X
Stopping your own program	✓	✓	✓
Stopping a program of another user	✓	X	X
Quick program	✓	✓	X
Quick change of set time	✓	✓	X
Quick change of set temperature	✓	✓	X
Assigning a program to a user of the user type	✓	✓	X
Creating a schedule	✓	✓	X
Editing a schedule	✓	✓	X
Defrost control	✓	X	X
Management of the illumination shelves in the unit (FIT version)	✓	X	X
Setting temperature measurement parameters	✓	X	X
Temperature value correction	✓	X	X
Setting the alarms	✓	X	X
Temporarily silencing the alarms	✓	✓	✓

Enabling / disabling the sound	✓	X	X
Saving a Quick Note	✓	✓	✓
Creating users accounts	✓	X	X
Changing user's settings	✓	X	X
Changing equipment's name	✓	X	X
Setting a time zone	✓	X	X
Changing the language	✓	X	X
Setting the automatic logout time	✓	X	X
System information preview	✓	✓	✓
Statistics preview	✓	✓	✓
WiFi settings	✓	X	X
LAN settings	✓	X	X
Setting e-mail reports	✓	X	X
Access to the archive	✓	X	X
Events preview	✓	✓	✓
Deleting events	✓	X	X
Copying data to a pendrive	✓	✓	X
Data preview	✓	✓	✓
Copying data to a pendrive	✓	✓	✓
Displaying data as a graph	✓	✓	✓
Deleting your own data	✓	✓	✓
Deleting all data	✓	X	X
Resetting the open door counter	✓	X	X

Super Admin account

The Super Admin account has no limits. Has access to the program management menu and to the settings menu, go to the [table 1](#).

Figure 74 Menu available for Super Admin

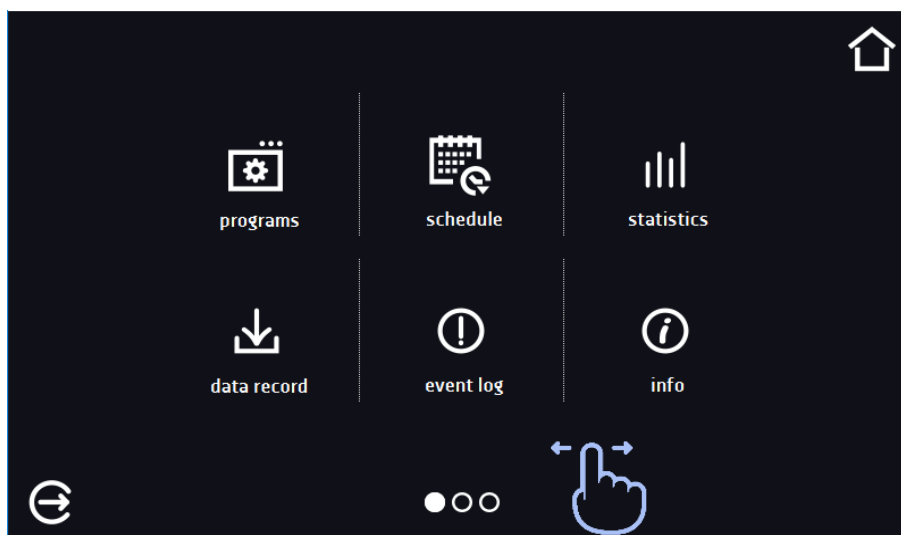

Information about the currently displayed window indicates .

Admin account



Has access to **programs menu**  and has rights and limitations in accordance with [table 1](#).

Figure 75 Menu available for Admin



User account:

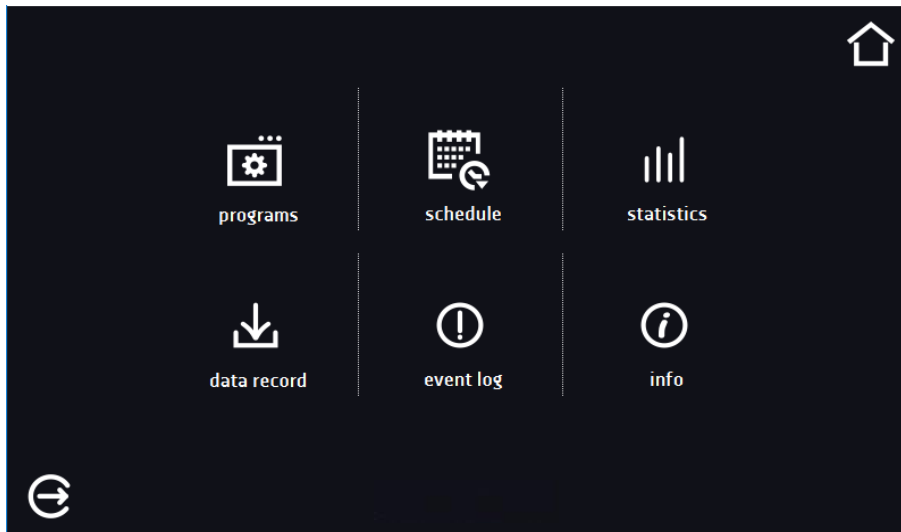

- has access to **programs menu** , where User can start **programs** previously assigned to him, check their statistics (**statistics**, **data register**), check events history of the equipment (**event log**) and the information about the system (**info**),
- can't create his own programs and schedules but start those which has been assigned to him by Super Admin,
- can't stop or edit a program or schedule which wasn't started by him,
- doesn't have access to create or edit schedules,
- the program started by the User can be stopped by a user with Super Admin privileges.



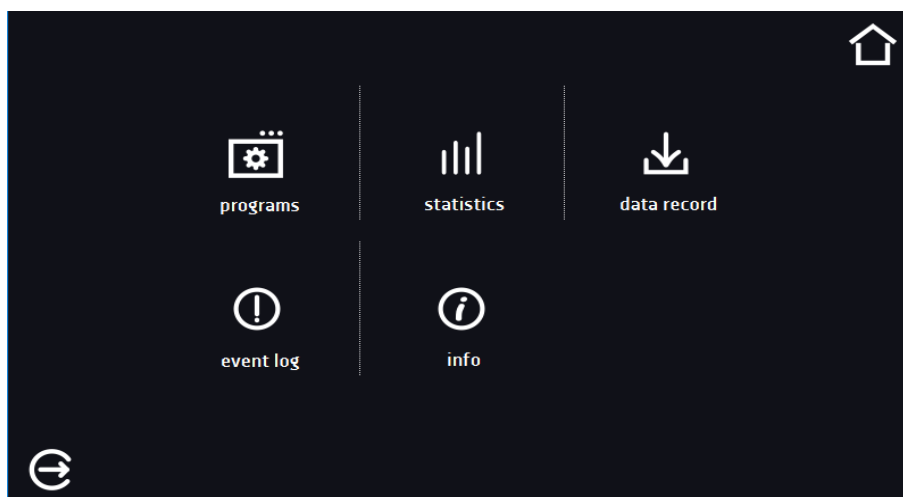





Other rights and limitations of the User type account are shown in [table 1](#).

Figure 76 Menu available for User



6.16. User settings panel

Go to the main menu  and press the icon . In this panel (*Figure 77*) you can:

	Change the name of the equipment – by default, the device serial number is entered.
 English	Change the language in the equipment's menu.
	Set the time after which the screen will be dimmed.
 <input type="checkbox"/>	Turn on/off the sound . Critical alarms will continue emitting a sound.
	Set the time after which the user will be automatically logged out. Available settings: off, 1 min, 3 min, 5 min, 10 min. Factory setting: enabled.
	Set the time after which the user will return to the home screen. Available settings: off, 1 min, 3 min, 5 min, 10 min.
	Set the automatic screen lock. Available settings: off, 5 min, 15 min, 30 min, 60 min. Factory setting: disabled.
 <input checked="" type="checkbox"/>	Enable / disable data register on a USB flash drive (connected to the USB port on the front of the unit).

 Only one feature can be enabled at the same time: automatic logout or automatic screen lock.

Figure 77 User settings panel



Confirms changes

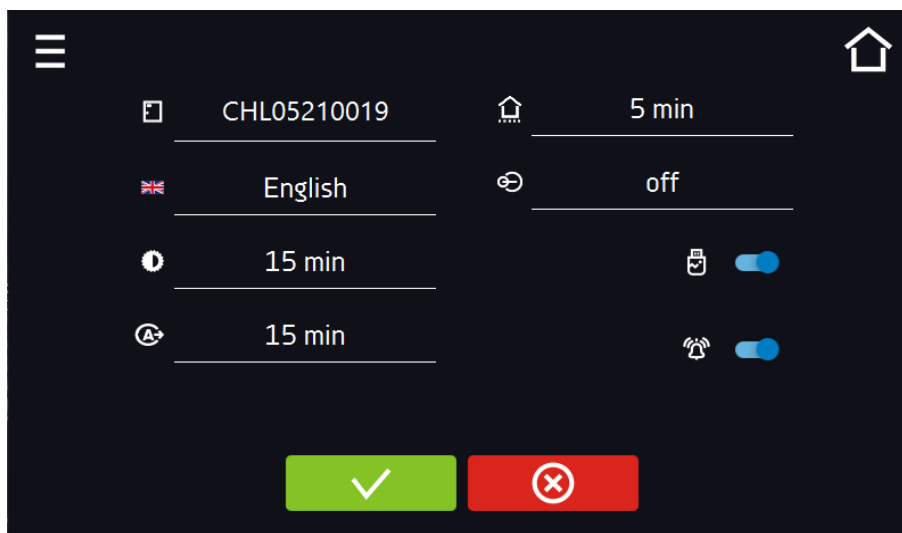

Cancels the entered changes



6.16.1. Unlocking the touch screen

When the automatic touch screen lock is enabled (Section 6.16), slide the blue circle into the white circle to unlock the screen.

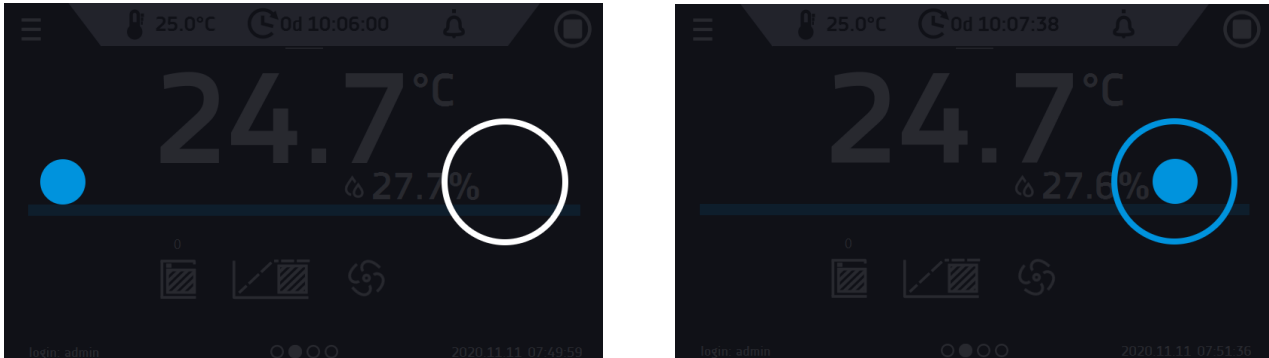
Figure 78 Unlocking the touch screen



6.17. Time

Go to the main menu  and press the icon . In this panel you can change the date and system time and time zone.

	The time and time zone must be set correctly during the first start-up.
---	---

Change of the date / system time

	If the date / system time is changed to the later date / time comparing with the data and events which are stored in the memory, they will remain in the register. If the date / system time is changed to the earlier date than the date / time which is stored in the memory, they will be transferred to the archive
---	---

After changing the date/system time the device will be restarted.

To change the date / system time it is necessary to press  in the window (Figure 79). The window will appear and you will be able to make changes (Figure 80).

Figure 79 Time change

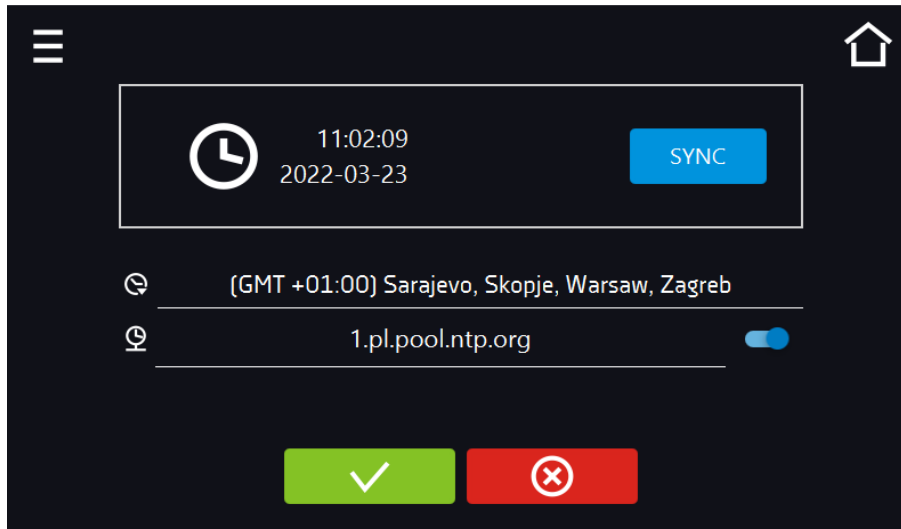

If the unit is permanently connected to the internet, the time will be synchronized with the time server.

Time synchronization is performed:

- manually using the button **SYNC**
- while enabling the automatic synchronization option and then every 12 hours (🕒)
- after starting the unit, then every 12 hours





If the time in the equipment was set incorrectly or it became out of sync with the period of use (which is natural), then if:

- automatic synchronization is turned on and the device is not connected to the internet but will be able to access the internet
- automatic synchronization is turned off and will be turned on, in addition, the unit is connected to the internet

the time will be synchronized with the NTP time server.

Figure 80 Date / time change



-  Confirms changes and restarts the device
-  Cancels the entered changes

Change of time zone

The change of time zone will not affect the date / time in data and events previously saved.

To change time zone, you have to press the button  in the window (Figure 79). Select the time zone from the drop-down list. After changing only the time zone, the device is not restarted.



Confirms changes



Cancels the entered changes



The same time zones on the device and computer are required for correct operation of the programs.

6.18. Alarms

6.18.1. *Alarms when set parameters are exceeded*

Press the main menu icon , and then press . Here you can set parameters related to alarms:

- **low alarm** – an alarm will be generated if the temperature drops below the set value by the value specified in this field,
- **high alarm** – an alarm will be generated if the temperature increases above the set value by the value specified in this field,
- **lower humidity alarm.** – an alarm will be generated if the humidity drops below the set value by the value specified in this field,
- **high humidity alarm.** – an alarm will be generated if the humidity increases above the set value by the value specified in this field.



Temperature:

In the "lower alarm" field you can enter a value from the range of -0.5°C to -5°C, and in the "upper alarm" field from the range of 0.5°C to 5°C.



Humidity:

In the "lower alarm" field you can enter a value from the range of -5% to -30%, and in the "upper alarm" field from the range of 5% to 30%.

Figure.81. Parameter exceedance alarms

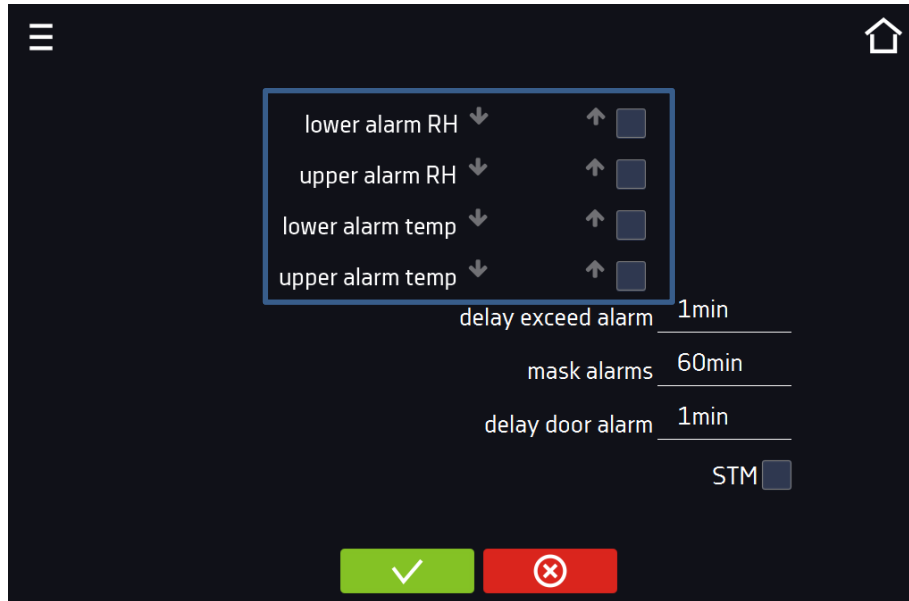

The high and low alarms can only be generated when the set temperature/humidity is reached.

- **temperature and humidity alarm delay:**
the alarm will be activated with a delay (1 min, 2 min, 5 min, 10 min, 15 min) after exceeding the set temperature/humidity.

6.18.1.1. Masking of parameter exceedance alarms.

Masking of alarms when the set parameters are exceeded can be used when new samples are added to the chamber or samples are added to those already incubated. During these activities, the set parameters, i.e. temperature and/or humidity, may be exceeded and alarms may be activated - parameter exceedance alarms are set assuming that stable conditions prevail in the chamber (temperature and humidity) and the door is closed. After opening the door and placing the samples in the chamber, time is needed for the parameters to stabilize - the alarm masking function allows you to delay alarms when the parameters are exceeded.

The parameter exceedance alarm will be triggered with a delay (15 min, 30 min, 45 min, 60 min, 120 min, 150 min, 180 min) after inserting new samples. The time is counted from the last time the door was opened. Setting 0 s means masking is disabled.



If the door is opened during the parameter exceedance alarm, the ongoing alarm will not be "masked". Only the next alarm can be masked.

Figure.82. Alarm masking

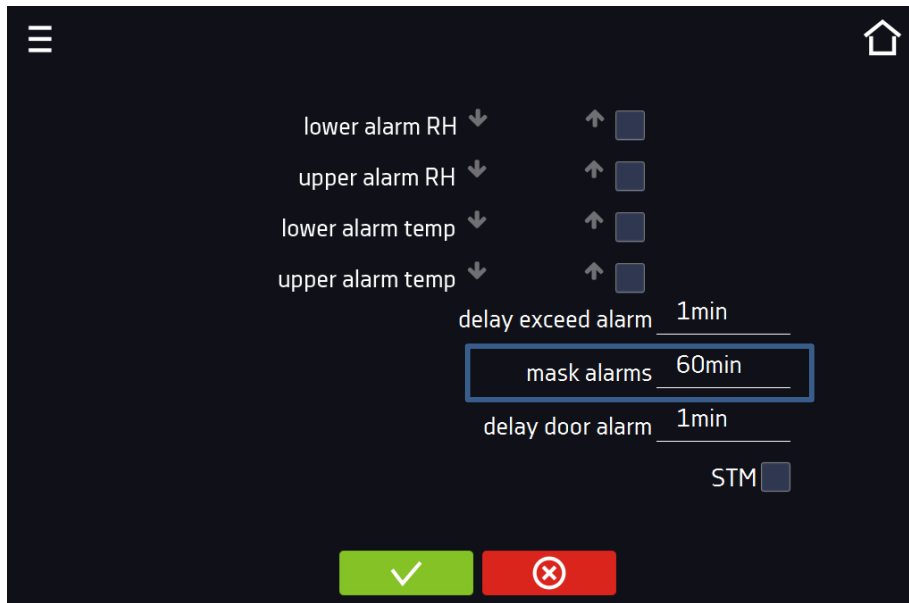
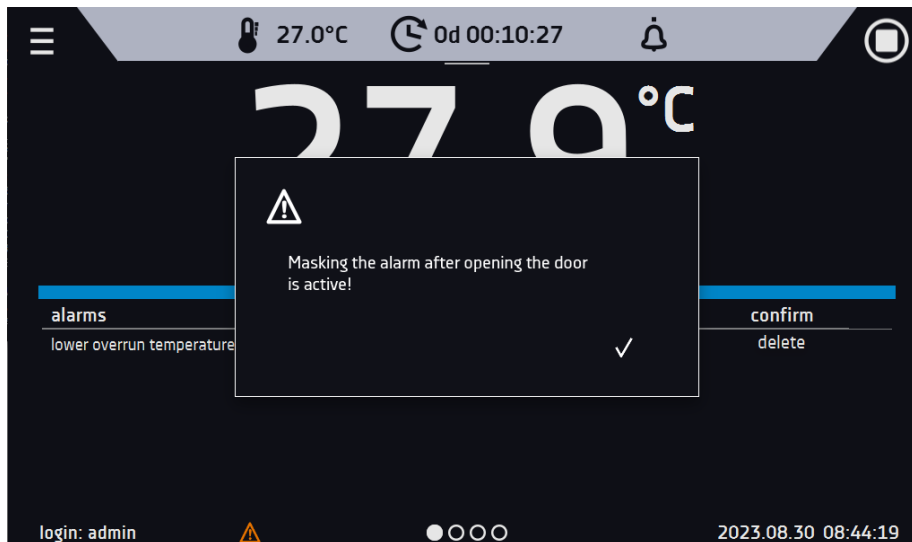

Figure.83. Alarm masking enabled



6.18.2. Open door alarm

All devices are equipped with an open door sensor. If the door is left open longer than the time set by the user, an acoustic signal, a red flashing alarm bar and the "door open" alarm with the status "active" will appear.

- **door open alarm delay:**
The door alarm will sound when the door is open for the user-selected time (30 sec, 1 min, 2 min, 5 min, 10 min).

Figure.84. Open door alarm delay

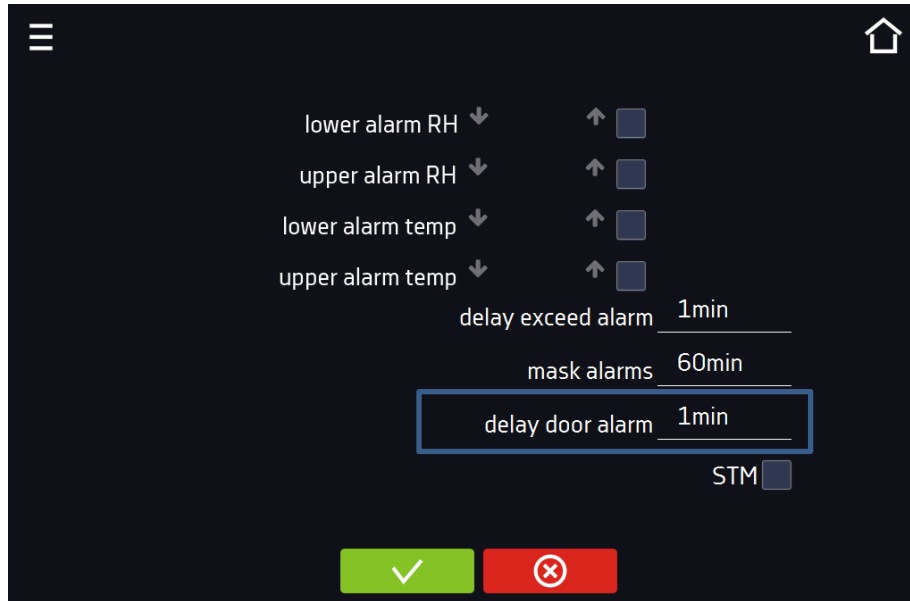

Confirm the changes.



Cancel the entered changes.

6.18.3. STM function

The STM (Smart Temperature Monitor) function informs the user if there is a problem in reaching or maintaining the set temperature. The user can enable/disable the function (Fig.85). If the STM function is enabled, the STM symbol will appear on the screen next to the temperature of the main sensor.

Figure. 85. Enable/disable STM function

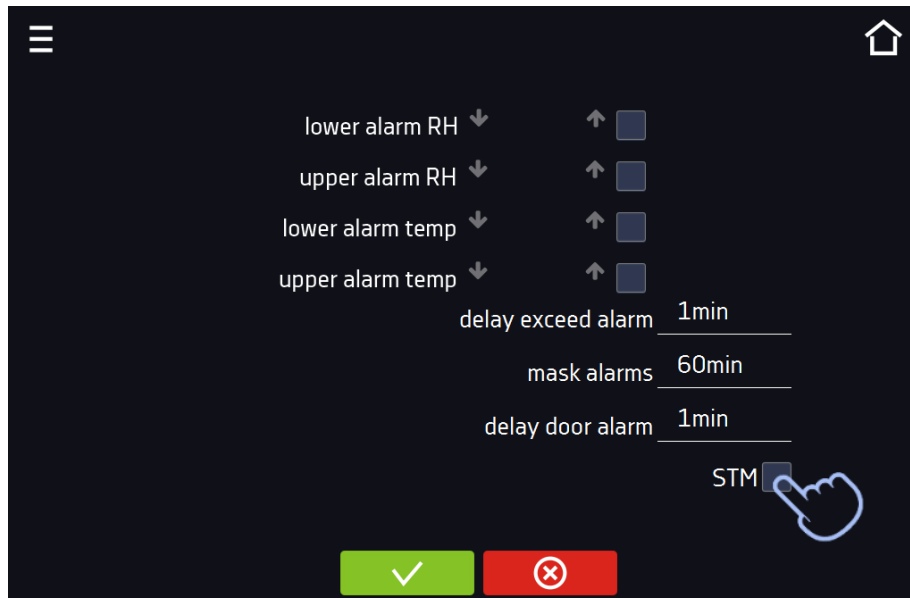

Confirm the changes.



Cancel the entered changes.

The function status is indicated by color:

- no inscription – option disabled,
- white color – option enabled, program is stopped (*Figure. 86*),
- blue color – option enabled (temperature monitoring), program running (*Figure. 87*),
- red color – option enabled, warning about problems with achieving/maintaining temperature (*Figure. 88*).

Figure. 86.



Figure. 87.



Figure. 88.



Possible causes of operation::

1. damaged heater,
2. the cartridge inserted into the chamber absorbs / releases too much energy.

If the color was red before opening the door, then the color changes to blue after opening the door.

If the function is activated (detection of problems with achieving/maintaining temperature):

- the warning 4.00.0.1.009... appears in the event log.
- the color of the STM inscription changes to red and remains red throughout the disruption, segment change, and program shutdown.
- when the state changes from red to blue, an entry about the end of function 4.00.0.1.010 appears in the event log

6.18.4. Mute option

The icon  in the main screen in the upper menu allows temporary switching off of the alarms sound (open door alarm, exceeding temperature range), e.g. to avoid door alarm during planned loading of the samples into the chamber.





To set the mute time, press the icon  and choose: 5, 10 or 15 minutes (*Figure 89*) however, the sounds of critical alarms (e.g. damage to the temperature sensor, over- and under-temperature protection) will be still emitted.

Figure 89 Setting the time of mute function

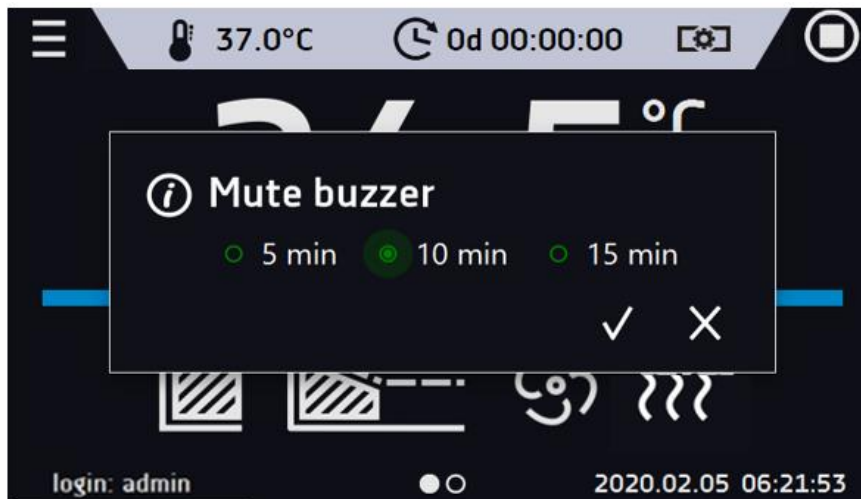

6.19. Network

Go to the main menu  and press the icon . In this panel you can change the settings for LAN or WiFi. Switch between LAN / WiFi network by pressing  or .

LAN settings:

- **IP** – the device's IP address
- **Mask** – an Ethernet network mask to which the device is connected
- **Gate** – Server's IP address or router's that manages the Ethernet network
- **DNS** – IP address of the domain name system
- **MAC** – the address of the network card, read-only

- **DHCP** – you can select if the server that allocates IP addresses is running on the local network. You can then skip setting IP, Masks, Gates

Icon **A** indicates the connection status:



Device connected to the network



Device disconnected from the network

Figure 90 LAN settings

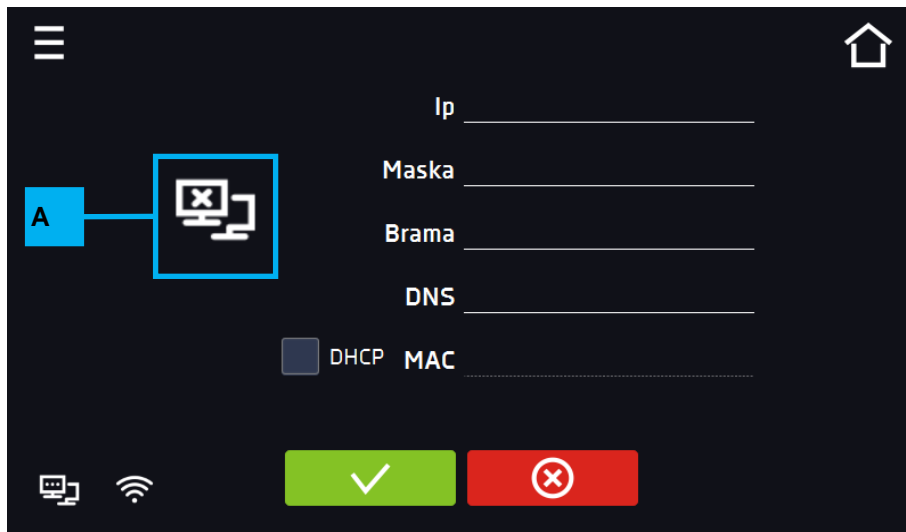

Confirms changes



Cancels the entered changes

WiFi settings:

-  – press to refresh network list,
- **SSID** – press to select network from the drop-down list,
- **PSK** – network password,
- **IP, Mask, Gate, DNS** – after a successful connection to the network these fields are automatically completed,
- **MAC** – physical address of the network card, read-only.

Figure 91 WiFi settings





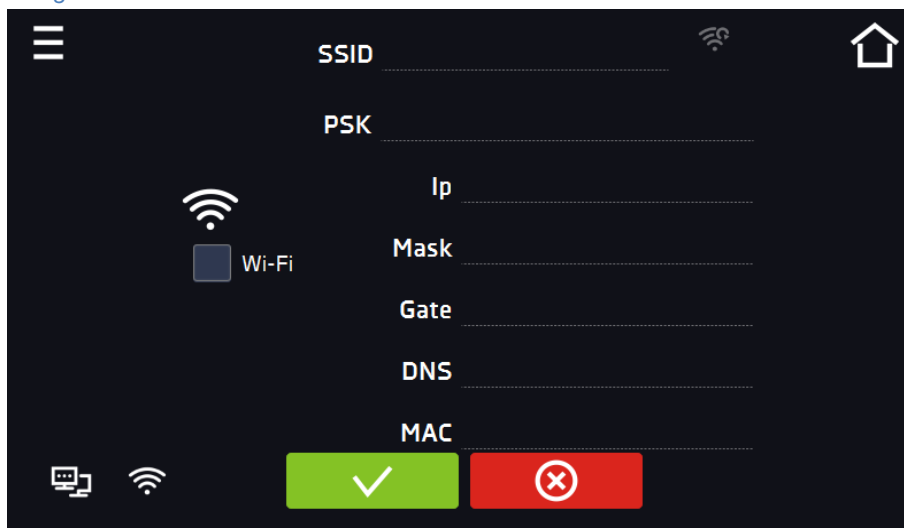

Confirms changes



Cancels the entered changes

6.20. E-mail reports

Go to the main menu  and press the icon . In this window you can set the parameters needed to activate e-mail notifications.

In the panel there are three windows:



Selection of event types for which notifications should be sent (Figure 92).

- **Activate** – turning on/off e-mail notifications,
- **Doors alerts** – alarms triggered by an open door,
- **Critical alerts** – critical alarms (e.g. sensor damage),
- **Temperature alerts** – alarms caused by too high or too low temperature,
- **Humidity alerts** - alarms caused by too high or too low humidity,
- **Programs events** – program-related events (e.g. adding, editing, deleting a program),
- **Users events** – events related to editing user settings (e.g. adding, editing, deleting users).

Figure 92 E-mail: events

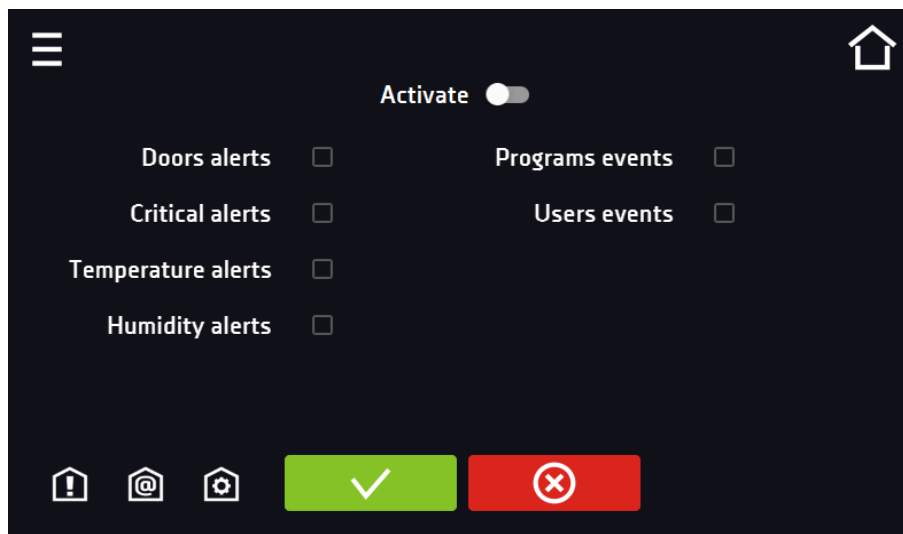

Confirms changes



Cancels the entered changes



If the "activate" option at the top of the panel is not enabled, emails will not be sent!

 Sender and recipients [\(Figure 93\)](#)

- **Sender** – sender's e-mail address
- **Recipients** – recipients e-mail addresses, maximum 3

Figure 93 E-mail: Sender – Recipients

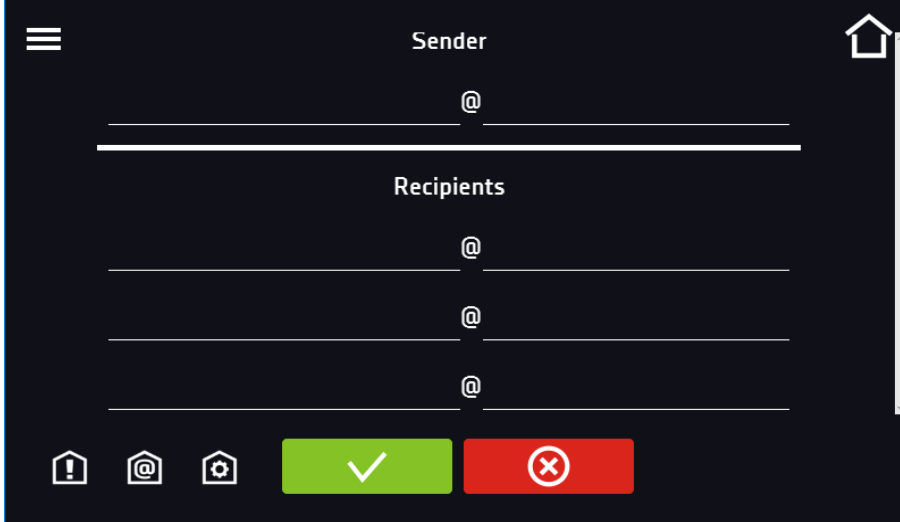

Confirms changes



Cancels the entered changes

 Configuration of the sender's e-mail account [\(Figure 94\)](#)



In this window, enter your e-mail account details:

- SMTP server user ID
- SMTP server password
- SMTP server host
- SMTP server port

You can also choose the **TLS** or **SSL** encryption method (get more information from your email account provider).

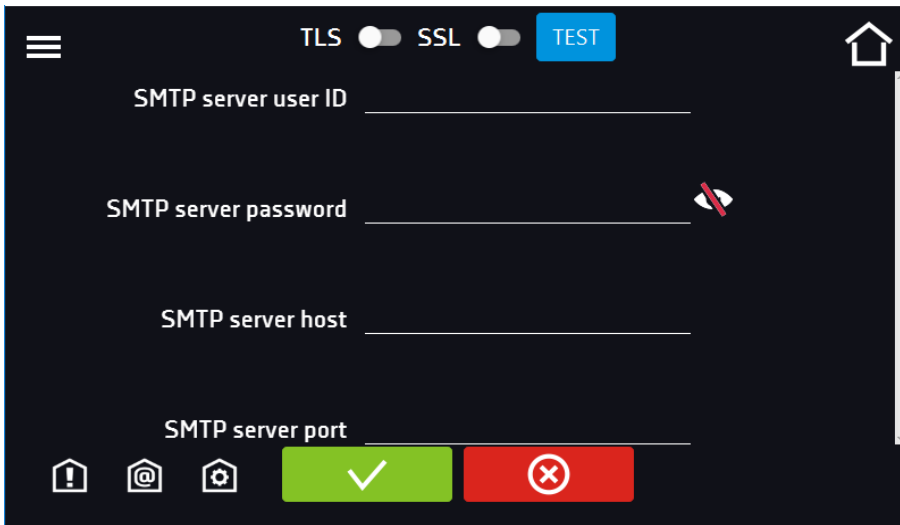
Figure 94 E-mail: email account configuration



-  TEST Connection test
-  Confirms changes
-  Cancels introduced changes



Before testing the connection, make sure that the device is connected to the network and has a properly configured network connection, see [Section 6.19](#).

6.21. Automatic defrosting function (standard for KK and KKS)

In this panel you can control the defrosting of the interior of the device. Option available for KK and KKS models. It's a standard equipment for phytotron version. The automatic defrost function is active when the "enable" box is checked

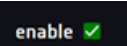
([Figure 95](#), ) , otherwise the function will not work (also default settings).

You can set:

- **Period [h]** – indicates the frequency of defrosting process for the set temperature $\leq 5^{\circ}\text{C}$.
- **Time [s]** – the time of defrosting,
- **Delay [min]** - time after defrosting that does not generate temperature alarms, given in minutes.

Pressing the button  – restores the default defrost settings (period [h]: 2, time [s]: 120, delay [m]: 0).



NOTE: the option  must be selected.

Figure 95 Defrosting program

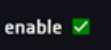
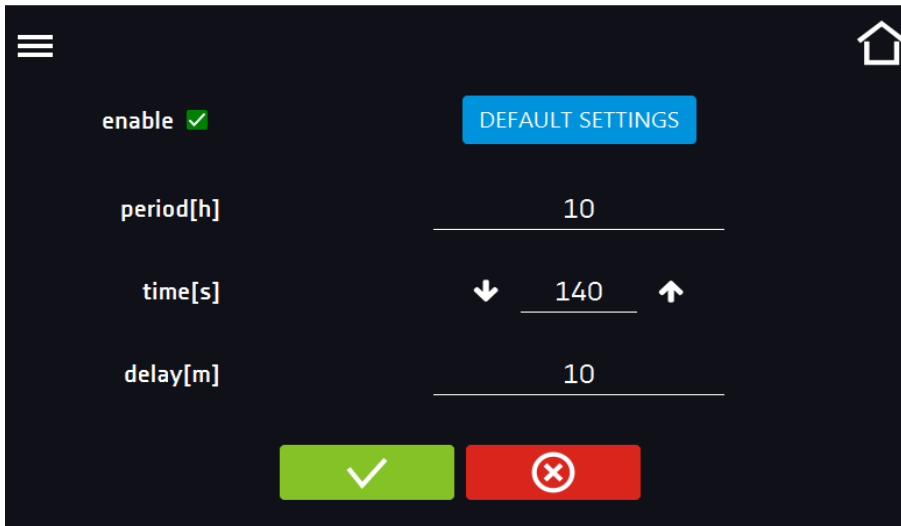

-  Confirms changes
-  Cancels the entered changes

6.22. Corrections

Go to the main menu  and press the icon . In this window (Figure 97) you can correct:

- temperature value indicated on the display by adding the correction value. The set correction value applies to the whole temperature range of the device. For example, if the average temperature displayed by the device indicates 20,0°C and the average temperature measured by independent, external sensor indicates 20,5°C, the correction should be set on +0,5°C. The average temperature should be calculated from chosen period of time e.g. 30 min. The correction available range is between -5°C to +5°C.
- humidity value indicated on the display by adding the correction value. The set correction value applies to 3 humidity ranges, between ranges the correction is calculated linearly.



The device has been calibrated by the manufacturer in accordance with applicable norms. The temperature shown on the display corresponds with a great accuracy to the temperature near chamber's sensor. For the correct operation of the device it is not necessary to use User's calibration. The User is performing temperature correction **on his own responsibility** and must be aware of consequences of changing manufacturer's settings. If the equipment was calibrated, calibration certificate **loses its validity**.

Figure 97 User's correction

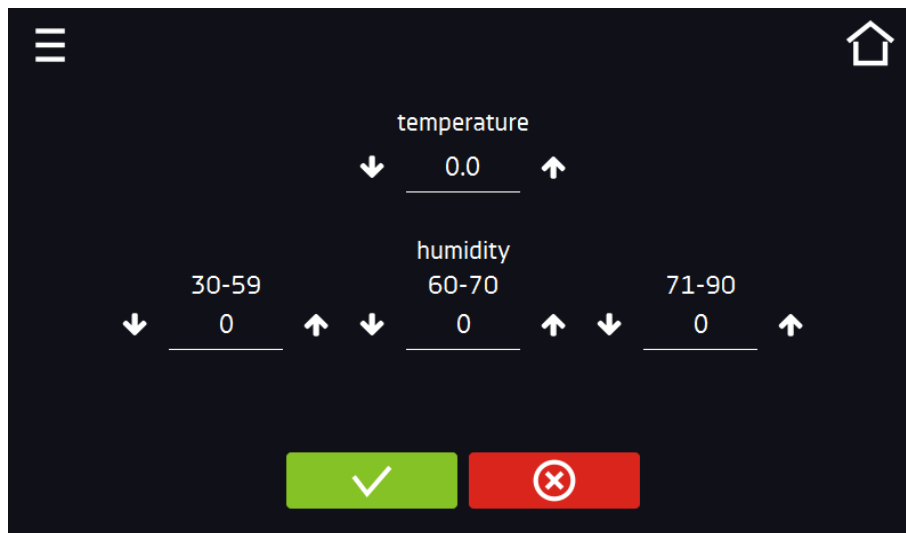

Confirms changes



Cancel the entered changes

7. INTERFACE

7.1. MODBUS TCP

The device allows status monitoring using the MODBUS TCP communication interface.

Connection parameters:

- IP address: same as device's (set in the panel [Section 6.19](#))
- port: 502

register INPUT REGISTERS
function READ_INPUT_REGISTERS (0x04)

Modbus adres	Offset	Type	Multiplier	Description
30000	0	int	10	temperature from the main sensor
30001	1	int	10	temperature from the additional sensor (option)
30002	2	int	10	humidity (option)
30003	3	bool	-	open door
30004	4	bit	-	b0 – door alarm b1 – upper temperature alarm b2 – lower temperature alarm b3 – over Protection b4 - under Protection b5 – main sensor error b6 – additional sensor error b7 – protection sensor error b8 – temperature sensors error b9 – humidity sensor error b10 – hardware error b11 – MRW error
30050	50	Int	-	Settings for each light point can be read at a separate address. The amount depends on the device configuration. FIT version: percentage value of the light (0-100)
...	...	int	-	
30068	68	Int	-	

8. TEMPERATURE PROTECTION

The device is factory fitted with sample protection - temperature protection. If any of the elements responsible for maintaining the set temperature is damaged or the user sets the temperature unconsciously, the set protection will work.

8.1. Temperature protection class

Standard equipment in the climatic chambers is a protection class 3.3 according to DIN 12880. The user programs the temperature value of the lower / upper protection. When the set temperature is exceeded, the cooling or heating system power will be turned off. When the temperature returns to the allowed range, the device will resume operation. The figure below shows how this works.

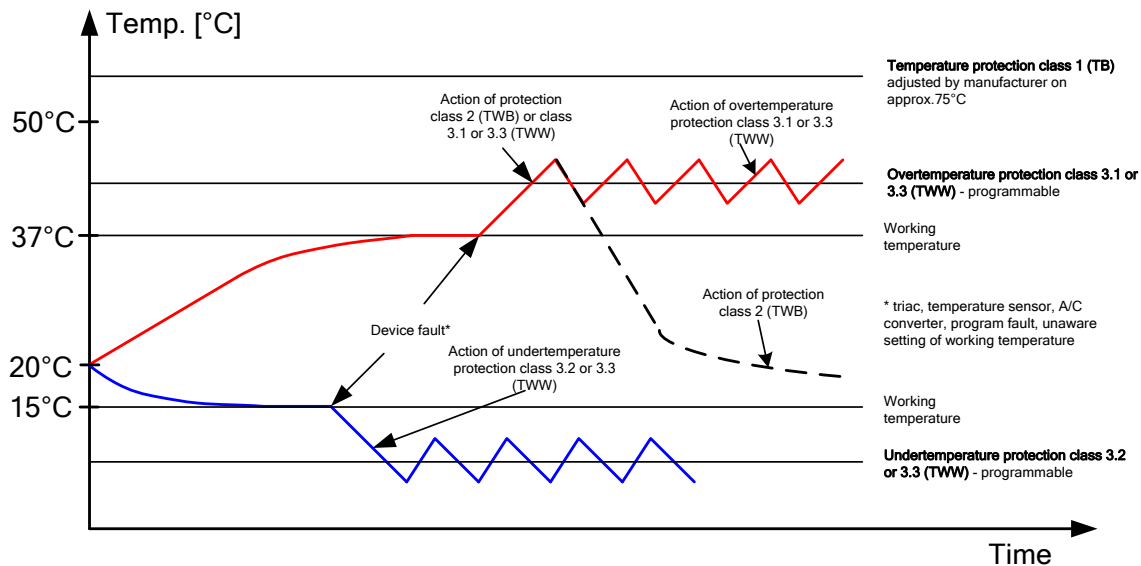

9. CONNECTING THE DEVICE TO A COMPUTER

Each device in the SMART PRO version can be connected to an Ethernet network or directly to a computer with a LAN cable (standard equipment). Using the Lab Desk program (standard equipment), you can program and monitor the operation of multiple devices with the SMART PRO controller. The features of the software have been described in a separate instruction manual.

10. OPERATION OF THE COOLING SYSTEM

If the unit is operating in low temperatures the evaporator may get covered with ice. This can affect the lower cooling efficiency of the device. To ensure proper operation of the device you should obey these principles:

1.	At temperatures above +8°C the air automatically defrosts the ice cover, defrosting is self-operating.
2.	At temperatures below +8°C the evaporator may be covered in ice and the device should be defrosted manually. If the unit works in a temperature below +8°C and the User does not defrost it periodically, the compressor may overheat and break down.
3.	The device is equipped with a protection mechanism against damaging the cooling system. The mechanism makes it impossible to turn on cooling when the temperature exceeds 45°C. As a result if the device has been programmed to go down to a lower temperature (e.g. from 60°C to 20°C) it may take longer for the program to operate until it reaches 45°C. The temperature inside the device is lowered naturally by emitting the heat to the surrounding environment. To speed up this process, it is recommended to open the chamber door for the time needed to cool the interior of the chamber.
4.	Always make sure that the door has been closed properly!

11. CLEANING AND MAINTENANCE OF THE DEVICE

	Disconnect the device from the power supply before carrying out any activities related to the cleaning! In the case of the battery back-up of the controller, also turn it off.
---	--

On the internal walls of the device (in particular the new one) made of stainless steel, discoloration (spots) may appear - which are not caused by factory defects, but only by the steel production process. They can be cleaned using extraction gasoline.

INOX products are manufactured with stainless steel. When used in standard laboratory conditions they do not rust. However it is possible that stains (which may look like rust) form on the steel surface (e.g. due to the kind of samples that are incubated in the chamber). In such case we recommend using cleaning solution (to clean the stains) which is dedicated to this particular application, e.g. Pelox.

	When cleaning stainless steel product with dedicated cleaning solution, one should pay attention to the suggestions and recommendations given in the instruction manual or in the safety data sheet of the cleaning solution.
---	--

11.1. Cleaning the housing, condensate tray and pump

1.	The housing of the device should be cleaned at least once a week, depending on the working conditions.
2.	The housing and door should be cleaned with caution using a soft cloth dampened with water.
3.	Only mild cleaning products should be used to clean the device.
4.	Electrical parts should not get in contact with water or detergent.
5.	Clean <u>the touch screen</u> using a soft cloth or a foam for cleaning touch screens.
6.	<u>USB port</u> can be cleaned with a vacuum cleaner to prevent accumulation of dirt inside the port.
7.	<p><u>The condensate tray and the container with a float</u> must be cleaned at least once a month (applies to KK 500, KK 700, KK 1200, KK 1450).</p> <p>To clean the tray:</p> <ol style="list-style-type: none"> 1. unscrew the knurled thumb screws securing the tray, 2. pull the tray out of the guides, 3. clean the tray with a sponge and clean water, 4. insert the tray into the guides and secure it with the knurled thumb screws.
8.	<p><u>The condensate level sensor in the tray</u> should be cleaned at least once a month. The condensate level sensor is located in the condensate tray. To clean the condensate level sensor:</p> <ol style="list-style-type: none"> 1. turn off the climatic chamber, 2. slide out the condensate tray from under the device, 3. lift the lid and open the condensate level sensor container, 4. rinse the protective strainer and the sensor disk under running water, 5. wipe the container with a dry cloth until it's completely dry, 6. install the disc and the protective strainer in the condensate level sensor container <p>Pay attention to the correct assembly of the protective disc (see the drawing below)</p> <ol style="list-style-type: none"> 7. slide back the condensate tray under the device.

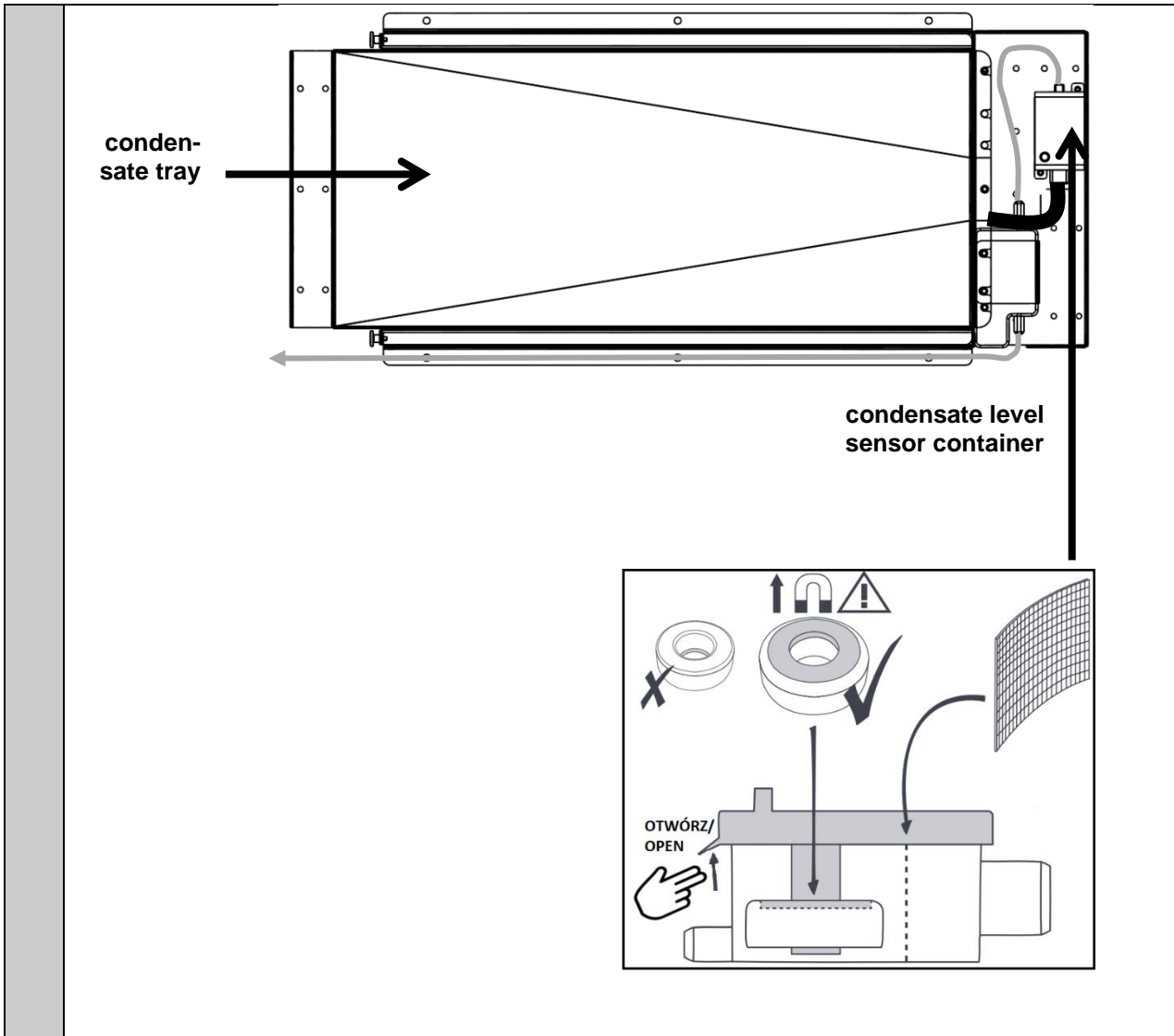

11.2. Interior cleaning

The interior of the climatic chambers is made of stainless steel 0H18 acc. with DIN 1.4301. Stainless steel 0H18 also corrodes, but much less and slower than other types of steel. To slow down the corrosion process as much as possible, this type of steel requires regular maintenance and cleaning. Avoid aggressive cleaning agents and preparations based on chlorine and bleach, do not allow stainless steel to come into contact with non-alloy steel, unless you are dealing with ground steel, and avoid materials that may scratch the surface.

1.	Before cleaning the interior of the device, empty the chamber.
2.	Open the door of the device, if necessary wait till the chamber has cooled down, take out the shelves and start cleaning of the device
3.	To clean the device, use a lint-free, lint-free, soft cloth and water or water with a mild detergent..
4.	In the case of ground steel, movements should be made in the direction of grinding on the surface.
5.	If rust occurs, use: - slight discoloration - household products for cleaning stainless steel with calcium carbonate or citric acid, - medium discoloration - 10% phosphoric acid solution; after cleaning, neutralize the acid with diluted ammonia or a mild alkaline detergent, - severe rust - use products for pickling and passivation of steel - for example Pelox FR-D

	After each cleaning, wipe the surface thoroughly with clean water.
6.	Having finished cleaning, you should allow the device to dry fully and instal all parts removed before cleaning.
7.	When washing, pay special attention to the sensors built in the chamber so as not to damage them.
8.	At least once a month clean the condenser with a vacuum cleaner, dry cloth or a soft brush. Placement of the condenser depending on the device: in the upper part (sizes 500, 700, 1200, 1450). In the climatic chambers KK 350, KK/KKS 115, KK/KKS 240, KK/KKS 400, KK/KKS 750 the condenser is located in the bottom. To access it, pull the ventilation cover (a) towards you and then pull it up (b). After cleaning the condenser (1), install the cover.

for: KK 500, KK 700, KK 1200, KK 1450

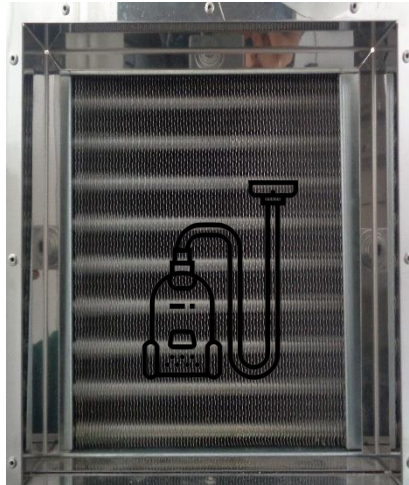

**view from the top
(the aggregate is located in the upper part of the device)**

for: KK 350, KK/KKS 115, KK/KKS 240, KK/KKS 400, KK/KKS 750



Failure to clean regularly may result in damage to the compressor and loss of the rights for repair under warranty.

11.3. Cleaning the touch screen

The touch screen is exposed to dirt, so it must be cleaned regularly. To clean the touch screen, use a clean and dry microfiber cloth. It is a very delicate material and collects dirt well.



Before using the cloth, **make sure that on the surface there are no crumbs or particles**. During cleaning, they can act like sandpaper and **scratch the surface of the screen**.

If the stains cannot be removed by dry cleaning, the cloth can be lightly dampened with water.

	<p>Do not use paper towels to clean the screen as it may cause microdamages.</p>
---	--

Before cleaning, lock the screen by pressing  on the top drop-down list (Figure 98).

Figure 98 Locking the screen

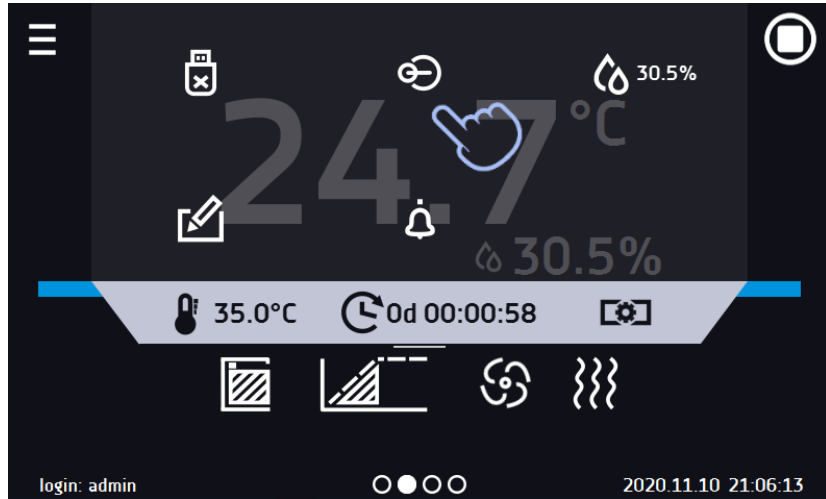

The screen is ready to be cleaned.

To unlock the touch screen, slide the blue circle into the white circle (Figure 99)

Figure 99. Unlocking the screen

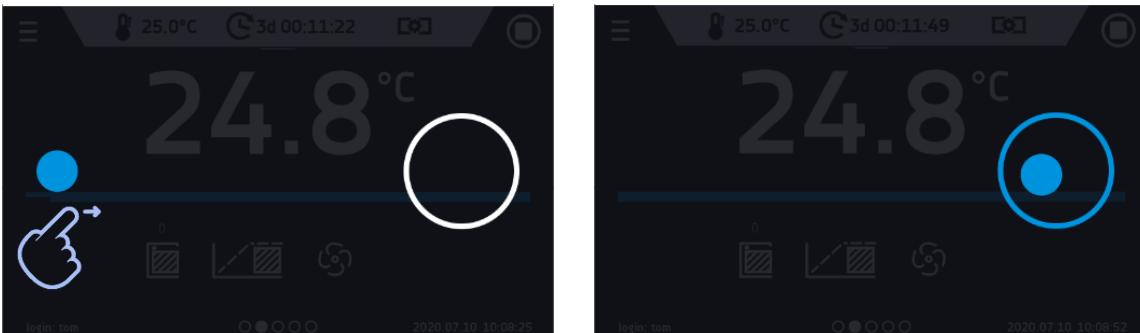

12. ADVICE ON HOW TO SAFELY STORE THE DEVICE

1.	Remove all objects from the chamber.
2.	Disconnect the device from the mains. If the unit is equipped with battery back-up of the controller (optional), also turn it off.
3.	Clean and dry the chamber.
4.	Leave the door open to avoid unpleasant odors.
5.	Turn off the water supply.
6.	Store in temperatures between 0°C and 50°C and relative humidity maximum 70%.

13. TROUBLESHOOTING

Before you contact Service Department:

1. make sure that the operation complies with the instruction manual of the device.
2. restart the device to make sure that the unit is not functioning properly. If it still does not work, disconnect the unit again from the mains and repeat the operation after one hour. Do the same with optional battery back-up of the controller.

Service

Visit the POL-EKO website at: www.pol-eko.com.pl in order to:

- get full contact details of technical service
- access to POL-EKO online catalogue, and information about accessories and related products
- receive additional product information and special offers

To receive information or technical assistance, contact the Service Department or visit the website: www.pol-eko.com.pl

13.1. Possible defects

Malfunction	What to check?	What to do?
The unit is not working	Check if the unit is plugged in correctly	Plug in the unit correctly
	Check if the circuit-breaker has tripped	Press the circuit breaker on the back of the device
	Check the voltage in the socket	Connect the device to a different socket, preferably from a different electrical circuit. Call a licensed electrician to check the electrical installation.
	Check if the power cable is broken	Change the cable
The unit is not cooling down	Check if the condenser is dirty	Clean the condenser
	Check if the unit is exposed to direct sunlight	Change the location of the unit
	Check if there is a heat emitter near the device	Change the location of the unit
	Check if the door is closed properly	Clean the gasket
The unit is not heating up	Check if the door of the unit is closed properly	Clean the gasket
	Check if the fan is turned on	Set the fan operation in the program
	Check if the ambient temperature is within the permissible values given in the technical data table?	Adjust the ambient temperature to the value given in this manual
The humidifier does not generate steam	Check if the program have humidity control enabled	Enable the humidity control
	Check if the water supply is open	Open the water supply
	KK: check if there's a water in the tank located at the back of the device (if there is no connection to the water supply) KKS: check if the reverse osmosis system is properly connected	KK: fill up the water in the tank KKS: connect properly the reverse osmosis system
The unit is working too loud	Check if the unit is not touching other objects or furniture etc.	Remove other objects
	Check if the door is properly leveled	Level the device
The door has dropped or is skewed	Check if the door is properly leveled	Level the device. If this does not help, contact the service.



For KK and KKS: gurgling sound of the refrigerant fluid flowing in the refrigerant circuit is normal.

13.2. Operation times of the UCAN ultrasonic humidifier components

The manufacturer of the UCAN ultrasonic humidifier declares trouble-free operation of the components contained in the humidifier for a specified period of time.

Subgroup	Component	Type	Declared operation time
1	Oscillator electronics board	UP-015A	2 years or 5000 h
1	Oscillator	UO-30	2 years or 5000 h
1	Set of oscillators	UP-015A/UO	2 years or 5000 h
2	UV lamp power supply	UV-INV/ER	3-4 years or 10000 h
2	UV lamp	UV-L01	2 years or 10000 h
2	Set of UV lamps	UV-UNT	2 years or 10000 h
1	Controller electronics board	UP-003D	3 years or 10000 h
1	DC power supply electronics board	UP-032(8A)	5 years or 10000 h
1	Water level sensors	FS-0684A, FS-0683A	4-5 years or 10000 h
1	Solenoid valves	VCW21-8G AC48V VCW32-8G AC48V	3 years or 10000 h

14. WARRANTY CONDITIONS

POL-EKO warrants that this product will be free from defects in material and workmanship for a period of two (2) years from date of the invoice. If a defect is present, POL-EKO will, at its option and cost, repair, replace, or refund the purchase price of this product to the customer, provided it is returned during the warranty period. This warranty does not apply if the product has been damaged by accident, abuse, misuse, or misapplication, or from ordinary wear and tear. If the required maintenance and inspection services are not performed according to the manuals and any local regulations, such warranty turns invalid.

The device that is being returned must be secured by the customer in the event of any damage or loss. The warranty will be only limited to the situations listed above. IT IS EXPRESSLY AGREED THAT THIS WARRANTY WILL BE IN LIEU OF ALL WARRANTIES OF FITNESS AND IN LIEU OF THE WARRANTY OF MERCHANTABILITY.

All complaints should be reported using the form available on the website <http://www.pol-eko.com.pl/en/service>

Compliance with local laws and regulations

The user is responsible for obtaining any approvals or authorizations required to launch and use the product. POL-EKO shall not be liable for any negligence in the above matter except when the refusal to obtain authorization is caused by a product defect.

15. RATING PLATE

The rating plate is located on the left side wall in the upper left corner. Below there is an example of a rating plate:

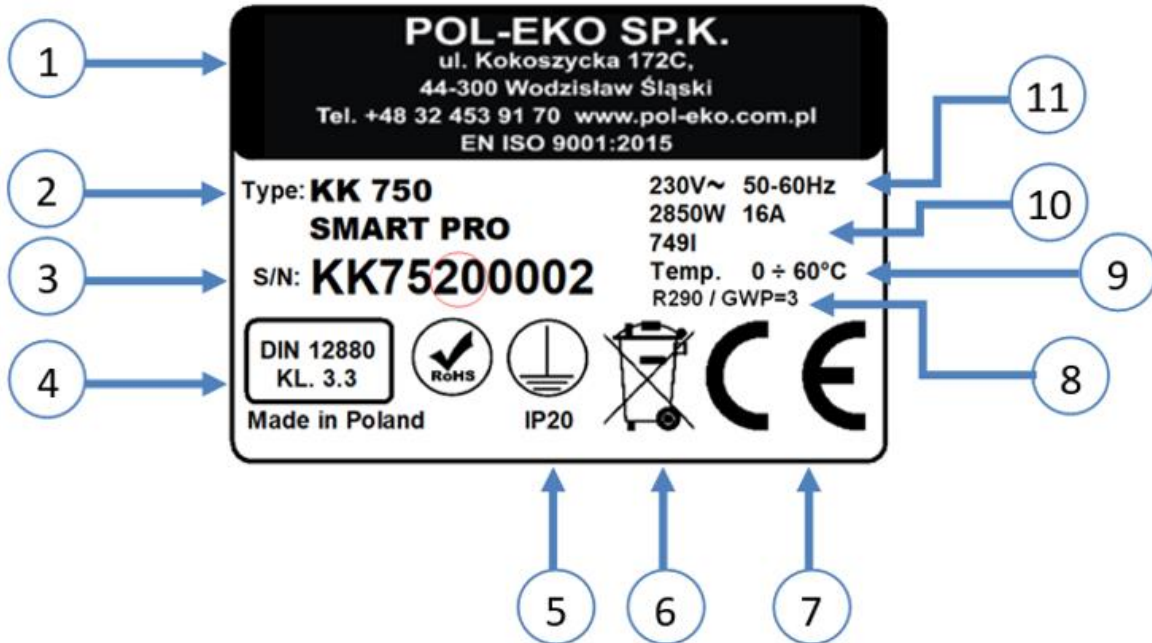

1. Manufacturer's data
2. Type of device
3. Serial number (the two marked digits indicate the year of manufacture of the device)
4. Temperature protection class according to DIN 12880
5. Degree of protection against electric shock (class I: protection against indirect contact) and IP enclosure protection rating
6. Disposal of used device according to WEEE2
7. CE marking as confirmation of compliance with the directives
8. Temperature range of the device
9. Information about cooling system (gas type and quantity)
10. Capacity of device
11. Acceptable range of voltage and frequency of mains supply

16. TECHNICAL DATA

Technical data are given with a tolerance of $\pm 5\%$, the working capacity of the chamber is always smaller. All the below technical data refers to standard units (without optional accessories).

16.1. KK models

Parameter	KK115	KK240	KK350	KK400	KK500	KK700	KK750	KK1200	KK1450	
Air convection	forced									
Chamber capacity [l]	109	245	322	416	470	600	749	1330	1485	
Door	double (external solid, internal glass) /external glass door (option)									
Temperature range[°C]	-	0... +60								
	FIT version	0... +60 (with the light turned on +10... +50)								
Temperature range [°F]	-	+32...+140								
	FIT version	+32...+140 (with the light turned on +50...+122)								
Temperature resolution [°C]	every 0,1									
Humidity range [%]	30...90									
Humidity resolution [%]	every 0,1									
Controller	microprocessor with external touch screen									
Interior	acid proof stainless steel according to DIN 1.4301									
Housing	Smart Pro	powder coated sheet								
	IG Smart Pro	stainless steel linen finish								
Overall dims ¹ [mm]	A width	660	820	640	1020	640	730	1260	1470	1450
	B height	1340	1600	2000	1850	1990	1990	2000	1990	1940
	C depth	960	1000	980	1000	1010	1070	1140	1060	1170
Internal dims [mm]	D width	460	600	480	800	480	540	1040	1270	1270
	D' width	-	-	-	-	510	600	-	1310	1340
	E height	540	800	1340	1040	1510	1510	1200	1510	1460
	F depth	440	500	500	500	640	660	600	660	760
	I height	-	-	1180	-	1360	1360	-	1360	1310
Max shelf workload ² [kg]	-	10	10	10	10	20	30	-	30	30
	PW ³ version	50	100	100	100	100	100	100	100	100
Max unit workload [kg]	60	90	100	120	100	150	140	300	300	
Nominal power	consult rating plate of the device									
Total maximum load power of electrical sockets (option)	$\Sigma_{max.} 200 [W]$									
Weight [kg]	90	140	125	185	130	170	275	220	230	
Protection	class 3.3									
Power supply	230 [V] $\pm 10\%$ / 50 [Hz] / 400V 50-60 Hz for KK 1200 FIT and KK 1450 FIT									
Refrigerant	R290 / GWP=3									
Shelves fitted/max	2/7	3/10	3/11	3/14	3/11	3/11	5/16	2 x 3/11	2 x 3/11	
Warranty	24 months									
Manufacturer	POL-EKO									

the above parameters apply to standard devices (without optional equipment)

1. depth does not include 50mm of power cable
2. on uniformly loaded surface
3. reinforced shelf

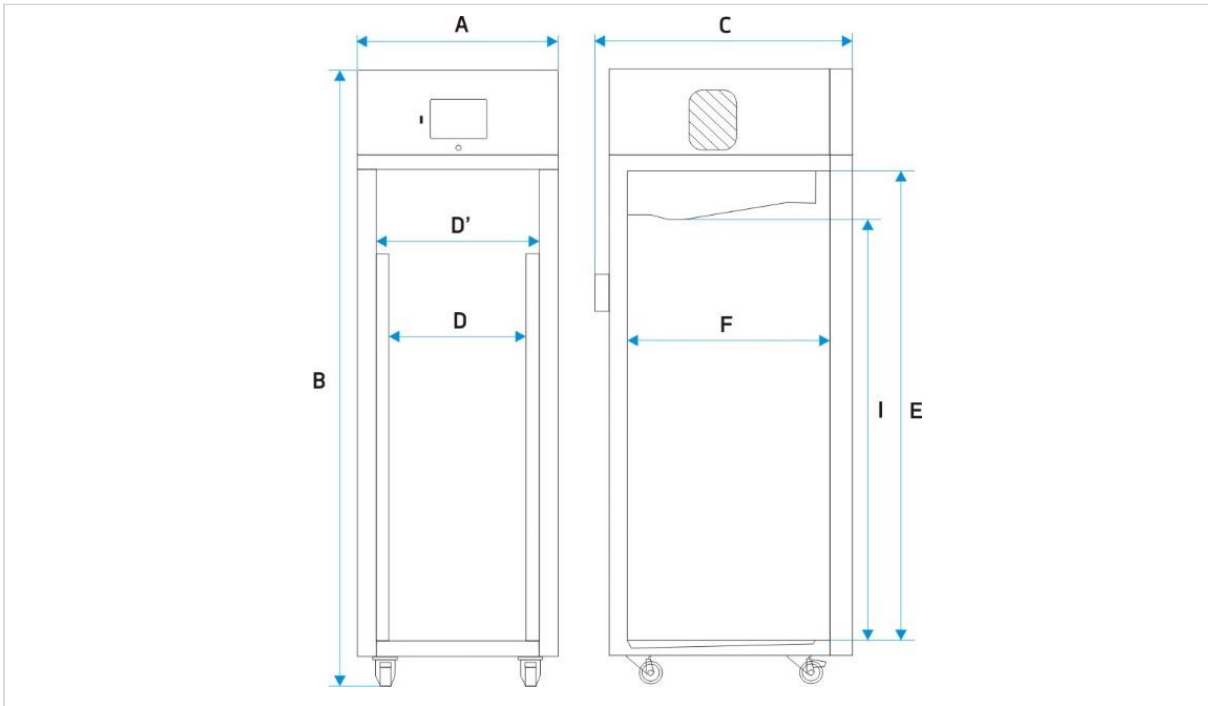

KK 500, 700, 1200, 1450

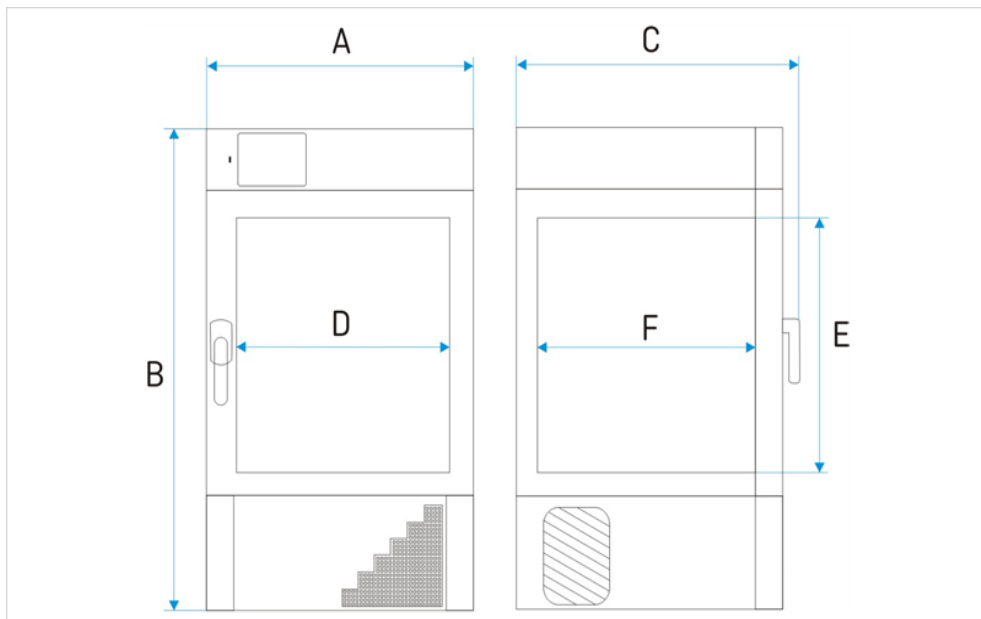

KK 115, 240, 400, 750

16.2. KKS models

Parameter	KKS115	KKS240	KKS400	KKS750	
Air convection	forced				
Chamber capacity [l]	109	240	416	749	
Door	double (external solid, internal glass)				
Temperature range [°C]	0... +100				
Temperature range [°F]	+32...+212				
Temperature resolution [°C]	every 0,1				
Humidity range [%]	10...90				
Humidity resolution [%]	every 0,1				
Controller	microprocessor with external touch screen				
Interior	acid proof stainless steel according to DIN 1.4301				
Housing	Smart Pro	powder coated sheet			
	IG Smart Pro	stainless steel linen finish			
Overall dims ¹ [mm]	A width	660	820	1020	1260
	B height	1330	1600	1850	2000
	C depth	820	880	880	980
Internal dims [mm]	D width	460	600	800	1040
	E height	540	800	1040	1200
	F depth	440	500	500	600
Max shelf workload ² [kg]	-	10	10	10	-
	version PW ³	50	100	100	100
Max unit workload [kg]	60	90	120	140	
Nominal power	consult rating plate of the device				
Total maximum load power of electrical sockets (option)	$\Sigma_{max.} 200 [W]$				
Weight [kg]	103	140	185	275	
Protection	class 3.3				
Power supply	230 [V] ±10% / 50 [Hz]		400 [V] / 50-60 [Hz]		
Refrigerant	R290 / GWP=3				
Shelves fitted/max	2/7	3/10	3/14	5/16	
Warranty	24 months				
Manufacturer	POL-EKO				

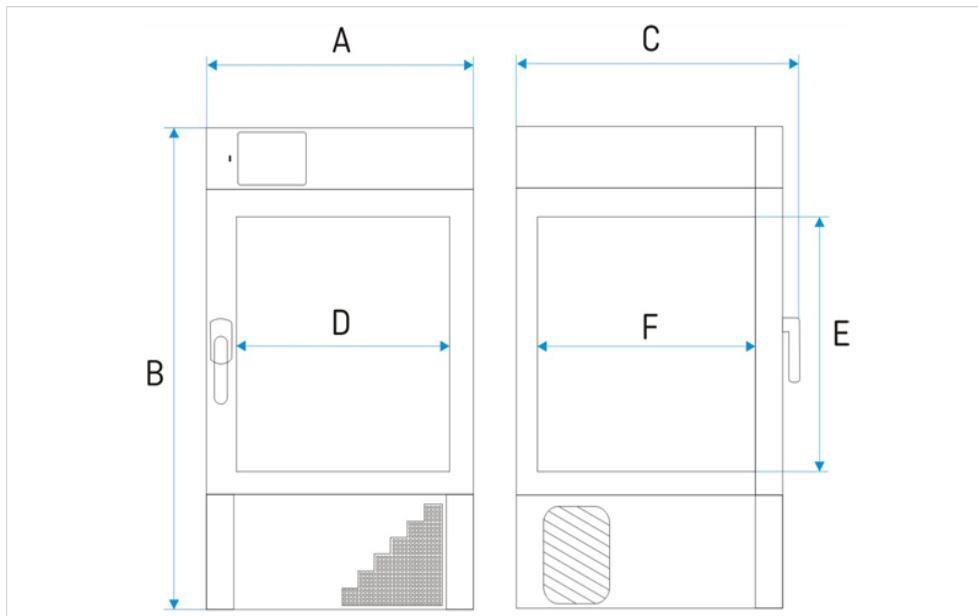

KKS 115, 240, 400, 750

17. DECLARATIONS OF CONFORMITY

		DEKLARACJA ZGODNOŚCI UE EU DECLARATION OF CONFORMITY	 POL-EKO
Produkt:	Komora klimatyczna	Product:	Climatic chamber
Model:	KK 115; KK 240; KK 350; KK 400; KK 500; KK 700; KK 750; KK 1200; KK 1450; KKS 115; KKS 240; KKS 400; KKS 750		Model:
w wersjach:	IG SMART PRO; SMART PRO		in version:
Nazwa i adres producenta:	POL-EKO A.Polok-Kowalska sp.k. ul. Kokoszycka 172 C 44-300 Wodzisław Śląski Polska/Poland		
Niniejsza deklaracja zgodności wydana zostaje na wyłączną odpowiedzialność producenta.	<i>This declaration of conformity is issued under the sole responsibility of the manufacturer.</i>		
Wymieniony powyżej przedmiot niniejszej deklaracji jest zgodny z odnośnymi wymaganiami unijnego prawodawstwa harmonizacyjnego:	<i>The object of the declaration described above is in conformity with the relevant Union harmonisation legislation:</i>		
LVD 2014/35/UE	LVD 2014/35/EU		
EMC 2014/30/UE	EMC 2014/30/EU		
RoHS 2015/863	RoHS 2015/863		
WEEE 2012/19/UE	WEEE 2012/19/EU		
PED 2014/68/UE	PED 2014/68/EU		
Odniesienia do odnośnych norm zharmonizowanych, które zastosowano lub do innych specyfikacji technicznych, w stosunku, do których deklarowana jest zgodność:	<i>References to the relevant harmonised standards used or references to the other technical specifications in relation to which conformity is declared:</i>		
LVD	PN-EN 61010-1:2011		
	PN-EN 61010-2-010:2015-01		
	PN-EN 60529:2003/A2:2014-07		
EMC	PN-EN IEC 61326-1:2021-10		
RoHS	PN-EN IEC 63000:2019-01		
Wodzisław Śl. 02.01.2023		W imieniu producenta podpisał:  Malgorzata Szafarczyk Dyrektor Generalny (CEO)	

Instruction manual KK, KKS SMART PRO

Manufacturer of control and measurement equipment
for laboratory tests and technological processes,
distributor in Poland of the following companies:
HAMILTON, NICKEL ELECTRO, RODWELL, THERMO SCIENTIFIC, WTW.

We produce:

- thermostatic cabinets
- laboratory refrigerators
- laboratory incubators
- devices with photoperiod and phytotron system
- drying ovens and sterilizers
- drying ovens with nitrogen blow
- laboratory freezers
- ultra-low freezers
- climatic chambers
- Caldera fluid and blanket warmers
- colony counters
- laboratory shakers
- stationary samplers
- Hydromat water dispensers
- Eurodrop stations
- FEKO+ waste water receipt station
- heating ovens
- cooled incubators
- fume hoods

We offer portable, laboratory and on-line equipment:

- pH-meters
- ionmeters
- dissolved oxygen meters
- conductivity meters
- photometers and spectrophotometers
- thermo reactors
- turbidity metres
- pH electrodes
- conductivity sensors
- oxygen probes
- heavy metals trace analyzers
- water baths
- autoclaves
- pH buffer solutions
- conductivity standards
- photometric tests
- laboratory accessories
- consumables

We organize:

- regional trainings
- individual trainings
- seminars

We provide:

- warranty and post-warranty service
- consultancy in the selection, maintenance and operation of laboratory equipment

POL-EKO LAB is Accredited by the Polish Centre for Accreditation (a member of ILAC) and provides accredited calibration of:

- thermostatic and climatic chambers (incubators, drying ovens, thermostatic cabinets, climatic chambers, freezers)
- water baths and thermo reactors
- autoclaves
- electric and electronic thermometers
- data loggers
- high temperature laboratory furnaces
- thermohygrometers
- laboratory sieves



AP 115

Calibration is confirmed with the issue of 'Calibration Certificate'.

Services outside the scope of accreditation:

- checking equipment for physicochemical measurements (meters and probes),
- carrying out IQ, OQ, PQ qualification procedures,
- mapping of temperature and humidity in the rooms.

Additional information about the services of POL-EKO LABORATORIUM POMIAROWE can be found on the website www.polekolab.pl and by phone: 32 453 91 97.



POL-EKO
Perfect Environment

☎ (+48) 32 453 91 70
✉ info@pol-eko.com.pl
🌐 www.pol-eko.com.pl

📍 **POL-EKO A. Polok – Kowalska sp.k.**
44-300 Wodzisław Śląski
ul. Kokoszycka 172 C

